



Dynaco Hydraulic Co., Ltd.
Huilong Industrial Zone 39
Ningbo, Zhejiang, China
Tel: 86-25-85360418
Email: info@dynacohydraulic.com
Web: www.dynacohydraulic.com

Mobile Cylinder Quick Reference Guide

Bleederless Telescopic Cylinders

Innovative Mobile Solutions From
Mobile Cylinder Division



Customer Unmet Need:

Bleeding cylinders is a tough dirty job for the dump truck and trailer industry. No one really wants to bleed the cylinder because it is a dirty, dangerous, and environmentally hazardous job as the mechanic must climb in and out of the dump bed to adjust the bleeder screw. Failure to bleed the cylinder will result in early cylinder failure in addition to cylinder mis-staging, and excessive costly hydraulic repairs.

Solution:

Dynaco has developed a special bleed system that is incorporated into the cylinder that allows air to bleed every time the dump bed goes up and down. This keeps the cylinder free of air and as a result the bleeding of oil and air is eliminated.



Contact Information:

Dynaco Hydraulic Co., Ltd.
Huilong Industrial Zone 39
Ningbo, Zhejiang, China
Tel: 86-25-85360418
Email: info@dynacohydraulic.com
Web: www.dynacohydraulic.com

Product Features:

- No air to bleed
- No speedy dry to sweep
- No EPA to deal with
- No more climbing into dirty beds
- Fewer hydraulic repairs
- Completely interchangeable with all manufacturers cylinders
- Size Range from 4" to the largest 9" cylinders
- Reduced weight over standard cylinders with bleeder screws

Hydraulic Cylinder Model Number Coding

The code and model numbers of a Parker Mobile (Commercial) Cylinder are references to its size and type. Using these numbers when ordering or inquiring greatly facilitates accurate understanding.

The following are examples of Parker Mobile Cylinder code and model numbers.

Single-acting Telescopic

S63MB-9-120

↑ ↑ ↑ ↑ ↑ ↑ ↑
 ① ② ③ ④ ⑤ ⑥ ⑦

Double-acting Telescopic

SD96CC-3-199

↑ ↑ ↑ ↑ ↑ ↑ ↑
 ① ② ③ ④ ⑤ ⑥ ⑦

Double-acting Piston Rod

D72LB-11-83











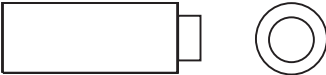

↑ ↑ ↑ ↑ ↑ ↑ ↑
 ① ② ④ ⑤ ⑥ ⑦

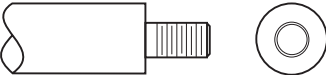
1. **S = Single-acting Telescopic or Displacement Cylinder**
 (Parker has also used SA, SF, and H as a prefix)
SD = Double-acting Telescopic Cylinder
D = Double-acting Piston Rod Cylinder
2. = **Nominal O.D. of the largest moving stage on Single-acting and Double-acting Telescopic cylinders**
 or the
Nominal Bore of Double-acting Piston Rod Cylinders
3. = **Number of moving stages or sleeves in a Telescopic Cylinder**
4. = **Mounting option on the body or base end of cylinder**
 (See mounting Option and Code Chart for mount descriptions)
5. = **Mounting option on the rod or plunger end of cylinder**
 (See mounting Option and Code Chart for mount descriptions)
6. = **Modification or design variation of the cylinder**
7. = **Length of cylinder stroke in inches**

OUR DESIGN ADVANTAGES INCLUDE:

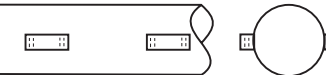
- * Longer sleeve overlap for improved stability and higher column loading.
- * Nylon tipped set screws that conform to the shape of the packing nut threads. It is nearly impossible for the packing nut to back off accidentally.
- * Snap-on, glass-filled bearings that absorb contaminants without damaging cylinder walls.
- * Threaded steel stop rings for easier servicing and more reliable stopping action.
- * External packing nuts give added support to the tube exterior while making service procedures easier.
- * Wave springs and chevron packing for self-compensating seals.
- * Polyurethane rod wipers that resist higher temperatures without extrusion.
- * Positive manual air bleeder prevents cavitation and "mushy" cylinder action, NOW BLEEDERLESS.
- * Cast steel mountings offer dependable strength. Pin-eye and rod-end are welded into a single unit.

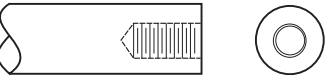
Mounting Options and Code Chart

Code Letter	Mount Description	Mount Sketch	Mount Location
A	Plain No Mount		Body or Rod
B	Pin-Eye Drilled Thru Rod		Rod
C	Pin-Eye Drilled Thru Lug		Body or Rod
D	Cross Tube		Body or Rod
E	Threaded		Body or Rod
F	Drilled and Tapped		Body or Rod
G	Flange Mount at Base		Body
H	Flange Mount Mid-Body		Body
J	Foot / Pad Mount		Body
K	Centerline Mount		Body
L	Double Lug Clevis Mount		Body or Rod
M	Trunnion Mount		Body
N	Rod End Drilled and Tapped		Rod
O	Ball Mount		Body or Rod
P	Socket Mount		Body or Rod

Hydraulic Cylinder Load & Displacements

“ S ” SERIES SINGLE-ACTING, SINGLE & MULTIPLE STAGE CYLINDERS

Sleeve or Plunger O.D. (in inches)	Effective Area in square inches	Load Capacity lbs @ 2000 p.s.i.	Displacement per inch of stroke in gallons *
1.75"	2.41"	4,811	0.010
2.75"	5.94"	11,880	0.026
3.75"	11.04"	22,089	0.048
4.75"	17.72"	35,441	0.077
5.75"	25.97"	51,935	0.112
6.75"	35.78"	71,570	0.155
7.90"	49.02"	98,034	0.212
9.38"	69.03"	138,059	0.299
10.75"	90.76"	181,526	0.393
12.50"	122.72"	245,438	0.531
14.00"	153.94"	307,877	0.666

“ SD ” SERIES DOUBLE-ACTING, MULTIPLE STAGE CYLINDER

Sleeve or Plunger O.D. (in inches)	Bore of Main or Sleeve (in inches)	Effective area (sq. inches) to extend	Effective area (sq. inches) to retract	Load capacity lbs @ 2000 p.s.i. extending	Load capacity lbs @ 2000 p.s.i. retracting	Displacement per inch of stroke (in gallons)* to extend	Displacement per inch of stroke (in gallons)* to retract
1.75"	2.25"	3.98"	1.57"	7,952	3,142	0.017	0.007
2.75"	3.25"	8.29"	2.35"	16,592	4,712	0.036	0.010
3.75"	4.25"	14.18"	3.14"	28,372	6,283	0.061	0.014
4.75"	5.25"	21.64"	3.92"	43,296	7,854	0.094	0.017
5.75"	6.25"	30.68"	4.71"	61,360	9,426	0.133	0.020
6.75"	7.25"	41.28"	5.49"	82,564	10,994	0.179	0.024
7.90"	8.44"	55.68"	6.97"	111,360	13,946	0.242	0.030
9.38"	9.88"	76.59"	7.56"	153,180	15,120	0.332	0.033
10.75"	11.50"	103.87"	13.11"	207,738	26,213	0.450	0.057
12.50"	13.00"	132.73"	10.01"	265,465	20,028	0.575	0.043
14.00"	14.50"	165.13"	11.19"	330,261	22,384	0.715	0.048

Note: The Effective area to RETRACT a Standard “SD” series double acting multiple stage cylinder is the effective area of the PLUNGER (plunger bore area minus the plunger O.D. area).

Example: Retract force for a SD94CC-8-190 (which has 5.75” O.D. plunger and fits in 6.25” bore) would be 9,426 lbs @ 2,000 psi, based on a 4.71 sq. in. effective area.

To calculate effective area in square inches: Multiply diameter times diameter times .78

Example: 5 dia. x 5 dia. = 25 x .78 = 19.63 Square inches of area

To calculate load capacity / cylinder force: Multiply effective area times operating pressure (psi)

Example: 19.63 Square inches x 1750 P.S.I = 34,361 lbs of force

To calculate the required gallons of fluid to extend a cylinder:

Add each “Displacement per inch of stroke” (from chart) for the required sleeve sizes.

Divide this total by the number of moving sleeves, then multiply that total by the desired cylinder stroke.

Note: The “Gallons required to extend” does not include the necessary fluid to fill an empty cylinder.

Example: Required fluid to extend a S83DC-40-134 single-acting telescopic cylinder with following stage sizes:

5.75" O.D.= .112
6.75" O.D.= .155
7.90" O.D.= .210
.477

.477 ÷ 3 = .159 gallons per inch of stroke

.159 gallons per inch x 134" of stroke = 21.31 gallons to extend cylinder

Closed Length Calculations for Single-Acting Single & Multiple Stage Cylinders

* Closed length (Lc) for S Models is computed by one of the three equations below. Model number and stroke required determines which equation to use. Example: To find Lc for S41 cylinder with 68" stroke. Under S41 column, use equation III, because the stroke is over 50".

$$L_c = \text{Stroke} + X_1 + X_2 = 68" + 7.50" + \frac{(68 - 50)}{10} = 68" + 7.50" + (1.8)$$

Use next largest whole number. = 68" + 7.50" + 2" = 77.50".

The closed length (Lc) is 77.50". Add Lc 77.50" to the stroke 68" for extended length of 145.50"

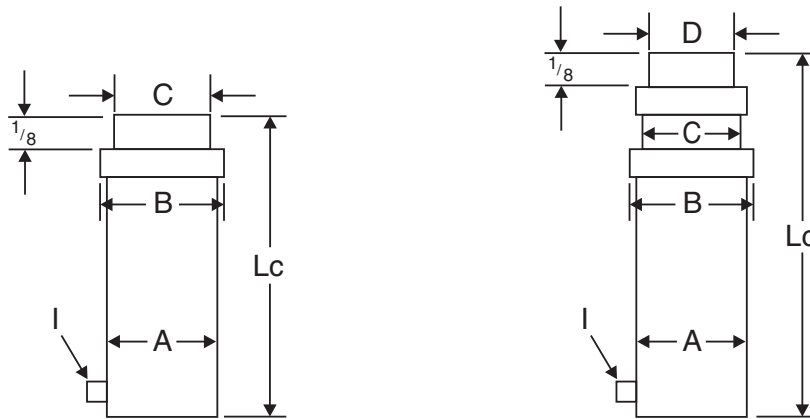

	SINGLE STAGE								2 STAGE							
Cylinder Dimensions (inches)		S31	S41	S51	S61	S71	S81	S91		S42	S52	S62	S72	S82	S92	
Main Cylinder O.D.	A	3 ³ / ₄	4 ³ / ₄	5 ³ / ₄	6 ³ / ₄	8	9 ¹ / ₈	10 ¹³ / ₁₆	A	4 ³ / ₄	5 ³ / ₄	6 ³ / ₄	8	9 ¹ / ₈	10 ¹³ / ₁₆	
Largest Packing Nut O.D.	B	4 ³ / ₈	5 ³ / ₈	6 ³ / ₈	7 ³ / ₈	8 ⁵ / ₈	9 ⁷ / ₈	11 ³ / ₄	B	5 ³ / ₈	6 ³ / ₈	7 ³ / ₈	8 ⁵ / ₈	9 ⁷ / ₈	11 ³ / ₄	
1st Sleeve O.D.	C	2 ³ / ₄	3 ³ / ₄	4 ³ / ₄	5 ³ / ₄	6 ³ / ₄	7 ⁷ / ₈	9 ³ / ₈	C	3 ³ / ₄	4 ³ / ₄	5 ³ / ₄	6 ³ / ₄	7 ⁷ / ₈	9 ³ / ₈	
2nd Sleeve O.D.	D								D	2 ³ / ₄	3 ³ / ₄	4 ³ / ₄	5 ³ / ₄	6 ³ / ₄	7 ⁷ / ₈	
3rd Sleeve O.D.	E								E							
4th Sleeve O.D.	F								F							
5th Sleeve O.D.	G								G							
6th Sleeve O.D.	H								H							
NPT Port	I	3 ³ / ₄	3 ³ / ₄	3 ³ / ₄	1	1	1 ¹ / ₄	1 ¹ / ₄	I	3 ³ / ₄	3 ³ / ₄	1	1	1 ¹ / ₄	1 ¹ / ₄	
Max. Stroke at 2000 PSI		71	84	88	95	118	128	190		126	137	138	164	186	265	
*To Find Closed Length - Lc	X	5.75	5.75	5.75	6.00	6.00	6.50	6.62	X	6.69	6.69	6.94	6.94	7.44	7.56	
Equation I	L _c	Stroke + X up to 35" stroke O.L. = 1 ¹ / ₄ "							L _c	Stroke 2 + X up to 35" stroke O.L. = 1 ¹ / ₄ "						
Equation II	X ₁	7.50	7.50	7.50	7.75	7.75	8.25	8.38	X ₁	8.44	8.44	8.69	8.69	9.19	9.31	
	L _c	Stroke + X ₁ 36" to 50" stroke O.L. = 3"							L _c	Stroke 2 + X ₁ 36" to 50" stroke O.L. = 3"						
Equation III	X ₂	Stroke - 50 10 (To next largest whole number)							X ₂	Stroke - 50 20 (To next largest whole number)						
	L _c	Stroke + X ₁ + X ₂ over 50" stroke O.L. = 3" + X ₂							L _c	Stroke 2 + X ₁ + X ₂ over 50" stroke O.L. = 3" + X ₂						

Closed Length Calculations for Single-Acting Single & Multiple Stage Cylinders

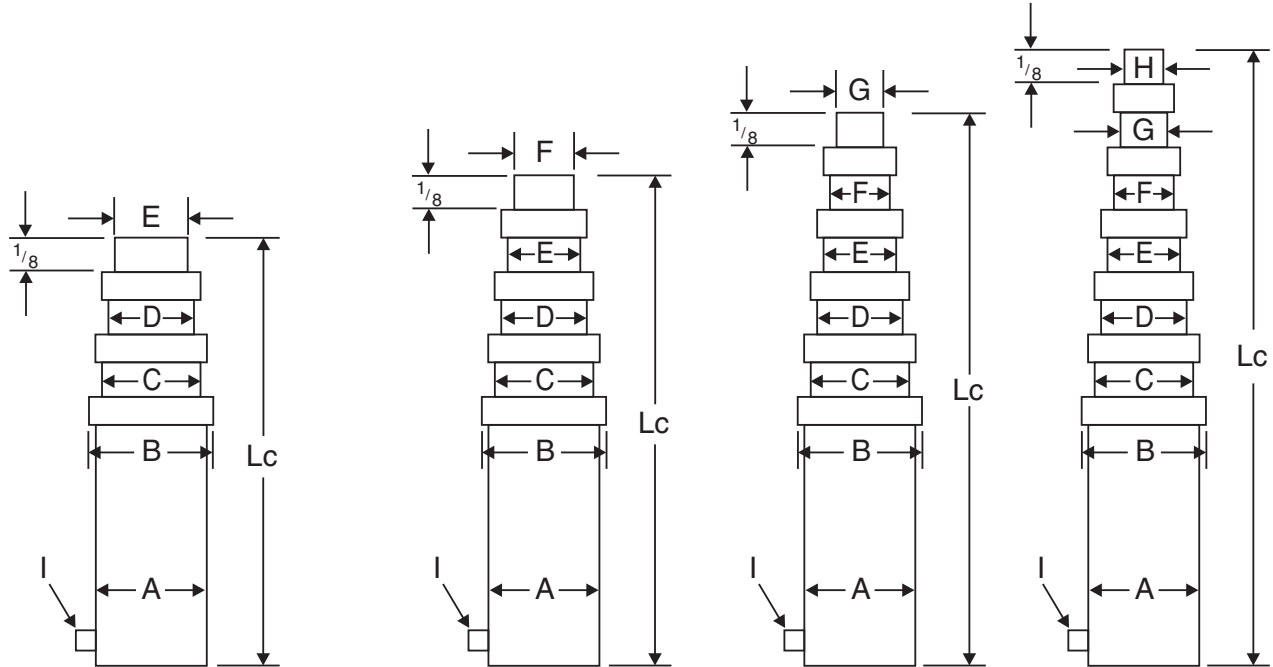

3 STAGE					4 STAGE					5 STAGE				6 STAGE						
	S53	S63	S73	S83	S93		S64	S74	S84	S94		S75	S85	S95		S86	S96			
A	5 ³ / ₄	6 ³ / ₄	8	9 ¹ / ₈	10 ¹³ / ₁₆	A	6 ³ / ₄	8	9 ¹ / ₈	10 ¹³ / ₁₆	A	8	9 ¹ / ₈	10 ¹³ / ₁₆	A	9 ¹ / ₈	10 ¹³ / ₁₆			
B	6 ³ / ₈	7 ³ / ₈	8 ⁵ / ₈	9 ⁷ / ₈	11 ³ / ₄	B	7 ³ / ₈	8 ⁵ / ₈	9 ⁷ / ₈	11 ³ / ₄	B	8 ⁵ / ₈	9 ⁷ / ₈	11 ³ / ₄	B	9 ⁷ / ₈	11 ³ / ₄			
C	4 ³ / ₄	5 ³ / ₄	6 ³ / ₄	7 ⁷ / ₈	9 ³ / ₈	C	5 ³ / ₄	6 ³ / ₄	7 ⁷ / ₈	9 ³ / ₈	C	6 ³ / ₄	7 ⁷ / ₈	9 ³ / ₈	C	7 ⁷ / ₈	9 ³ / ₈			
D	3 ³ / ₄	4 ³ / ₄	5 ³ / ₄	6 ³ / ₄	7 ⁷ / ₈	D	4 ³ / ₄	5 ³ / ₄	6 ³ / ₄	7 ⁷ / ₈	D	5 ³ / ₄	6 ³ / ₄	7 ⁷ / ₈	D	6 ³ / ₄	7 ⁷ / ₈			
E	2 ³ / ₄	3 ³ / ₄	4 ³ / ₄	5 ³ / ₄	6 ³ / ₄	E	3 ³ / ₄	4 ³ / ₄	5 ³ / ₄	6 ³ / ₄	E	4 ³ / ₄	5 ³ / ₄	6 ³ / ₄	E	5 ³ / ₄	6 ³ / ₄			
F						F	2 ³ / ₄	3 ³ / ₄	4 ³ / ₄	5 ³ / ₄	F	3 ³ / ₄	4 ³ / ₄	5 ³ / ₄	F	4 ³ / ₄	5 ³ / ₄			
G						G					G	2 ³ / ₄	3 ³ / ₄	4 ³ / ₄	G	3 ³ / ₄	4 ³ / ₄			
H						H					H				H	2 ³ / ₄	3 ³ / ₄			
I	3/4	1	1	1 ¹ / ₄	1 ¹ / ₄	I	1	1	1 ¹ / ₄	1 ¹ / ₄	I	1	1 ¹ / ₄	1 ¹ / ₄	I	1 ¹ / ₄	1 ¹ / ₄			
	181	186	204	224	312		238	262	265	352		335	336	410		T.B.A.	T.B.A.			
X	7.62	7.88	7.88	8.38	8.50	X	8.81	8.81	9.31	9.44	X	9.75	10.25	10.38	X	11.19	11.31			
L _c	$\frac{\text{Stroke}}{3} + X$ O.L. = 1 ¹ / ₄ " up to 50" stroke					L _c	$\frac{\text{Stroke}}{4} + X$ O.L. = 1 ¹ / ₄ " up to 70" stroke					L _c	$\frac{\text{Stroke}}{5} + X$ O.L. = 1 ¹ / ₄ " up to 85" stroke				L _c	$\frac{\text{Stroke}}{6} + X$ O.L. = 1 ¹ / ₄ " up to 100" stroke		
X ₁	9.38	9.62	9.62	10.12	10.25	X ₁	10.56	10.56	11.06	11.19	X ₁	11.50	12.00	12.12	X ₁	12.94	13.06			
L _c	$\frac{\text{Stroke}}{3} + X_1$ O.L. = 3" 51" to 75" stroke					L _c	$\frac{\text{Stroke}}{4} + X_1$ O.L. = 3" 71" to 100"					L _c	$\frac{\text{Stroke}}{5} + X_1$ O.L. = 3" 86" to 125" stroke				L _c	$\frac{\text{Stroke}}{6} + X_1$ O.L. = 3" 101" to 150" stroke		
X ₂	$\frac{\text{Stroke} - 75}{30}$ (To next largest whole number)					X ₂	$\frac{\text{Stroke} - 100}{40}$ (To next largest whole number)					X ₂	$\frac{\text{Stroke} - 125}{50}$ (To next largest whole number)				X ₂	$\frac{\text{Stroke} - 150}{60}$ (To next largest whole number)		
L _c	$\frac{\text{Stroke}}{3} + X_1 + X_2$ O.L. = 3" + X ₂ over 75" stroke					L _c	$\frac{\text{Stroke}}{4} + X_1 + X_2$ O.L. = 3" + X ₂ over 100" stroke					L _c	$\frac{\text{Stroke}}{5} + X_1 + X_2$ O.L. = 3" + X ₂ over 125" stroke				L _c	$\frac{\text{Stroke}}{6} + X_1 + X_2$ O.L. = 3" + X ₂ over 150" stroke		

Hydraulic Oil Recommendations

All cylinder parts, with the exception of a few items, are lubricated by the hydraulic oil in the circuit. Particular attention must be paid to keep the oil in the circuit clean. Whenever there is a hydraulic component failure (cylinder, pump, valve), and there is a reason to feel that metal particles may be in the system, the oil must be drained, the entire system flushed clean, and any filter screens thoroughly cleaned or replaced. New oil should be supplied for the entire system. Oil suitable and recommended for use in circuits involving Dynaco's cylinders should meet the following specifications:

***These suggestions are intended as a guide only.
Obtain your final oil recommendations from your oil supplier.***

Viscosity Recommendations:

Optimum operating viscosity is considered to be about 100 SSU.

- * 50 SSU minimum @ operating temperature
7500 SSU maximum @ starting temperature
- * 150 to 225 SSU @ 100° F. (37.8° C.) (generally)
44 to 48 SSU @ 210° F. (98.9° C.) (generally)

Other Desirable Properties:

Viscosity Index: 90 minimum
Aniline point: 175 minimum

Additives Usually Recommended:

Rust and Oxidation (R & O) Inhibitors
Foam Depressant

Other Desirable Characteristics:

Stability of physical and chemical characteristics.
High demulsibility (low emulsibility) for separation of water, air and contaminants.
Resistant to the formation of gums, sludges, acids, tars and varnishes.
High lubricity and film strength.

General Recommendations:

A good quality hydraulic oil conforming to the characteristics listed above is essential to the satisfactory performance and long life of any hydraulic system.

Oil should be changed on regular schedules in accordance with the manufactures recommendations and the system periodically flushed.

Oil operating temperature should not exceed 200° F. (93° C.) with a maximum of 180° F. (82° C.) generally recommended. 120° F. to 140° F. (50° C. to 60° C.) is generally considered optimum. High temperatures result in rapid oil deterioration and may point out a need for an oil cooler or a larger reservoir. The nearer to optimum temperature, the longer the service life of the oil and the hydraulic components.

Reservoir size should be large enough to hold and cool all the fluid a system will need, yet it should not be wastefully large. Minimum required capacity can vary anywhere between 1 and 3 times pump output. The reservoir must be able to hold all of the fluid displaced by retracted cylinders when the system is not operating, yet provide space for expansion and foaming.

Oil poured into the reservoir should pass through a 100 mesh screen. Pour only clean oil from clean containers into the reservoir.

Never use Crank Case Drainings, Kerosene, Fuel Oil, or any Non-Lubricating Fluid, such as Water.

Approximate SSU at . . .

Oil Grade	100° F. (37.8° C.)	210° F. (98.9° C.)
SAE 10	150	43
SAE 20	330	51

Normal Temperatures:

0° F. (-18° C.) to 100° F. (37.8° C.) ambient
100° F. (37.8° C.) to 180° F. (82.2° C.) system

Be sure the oil you use is recommended for the temperature you expect to encounter.

Front Mount Dump Body Stroke & Lifting Calculations

Note: This guide is for use to determine approximate stroke and lifting requirements for a Front Mount Dump Body, they should not be used for Frameless Type Trailers, Underbody, Telescopic Farm (slant forward or rearward), or Scissor Type Hoists. Final dimensions and calculations should be determined by an engineering drawing.

Formula for Calculating Initial Required Cylinder Force to Lift a Load

$$\frac{\text{Load (lbs)} \times \text{"A"}}{\text{"B"}} = \text{Initial required cylinder force}$$

Example

$$\frac{50,000\# \times 85\text{"}}{166\text{"}} = 25,603\# \text{ of force to start the lift}$$

Dynaco Telescopic Lifting Capacities

Stage O.D. inches	System operating pressure			
	800 psi	1000 psi	1500 psi	2000 psi
2.75"	4752	5940	8909	11879
3.75"	8836	11045	16567	22089
4.75"	14176	17721	26581	35441
5.75"	20774	25967	38951	51935
6.75"	28628	35785	53677	71570
7.90"	39213	49017	73525	98034
9.37"	55165	68956	103434	137911

Note: For a good design, initial pressure should not exceed 800 psi at start of lift. Effective force (capacity) is only that of the sleeve / stage which is moving and will decrease as cylinder changes to the next moving sleeve. The effective force will also be reduced if the cylinder is pushing at an angle.

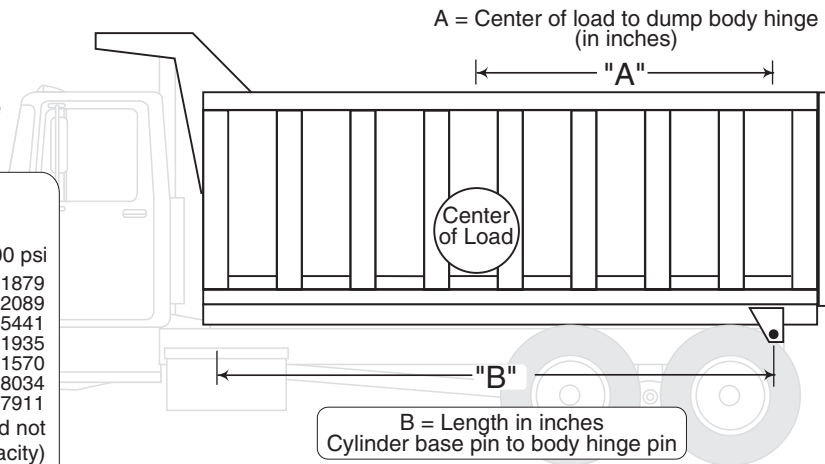

Formula for Calculating the Required Cylinder Stroke for a Dump Angle

$$\text{"B"} \times \text{"D"} = \text{Approximate Stroke}$$

Example

$$166\text{" (B)} \times .845\text{ (D)} = 140\text{" Stroke}$$

Dump Angle Multipliers

"D" = Dump Angle

.715	=	42 deg
.733	=	43 deg
.750	=	44 deg
.765	=	45 deg
.780	=	46 deg
.797	=	47 deg
.813	=	48 deg
.830	=	49 deg
.845	=	50 deg
.861	=	51 deg
.877	=	52 deg
.892	=	53 deg
.903	=	54 deg
.923	=	55 deg
.939	=	56 deg
.954	=	57 deg

Normal minimum dump angle is 45 degree
Normal maximum dump angle is 57 degree

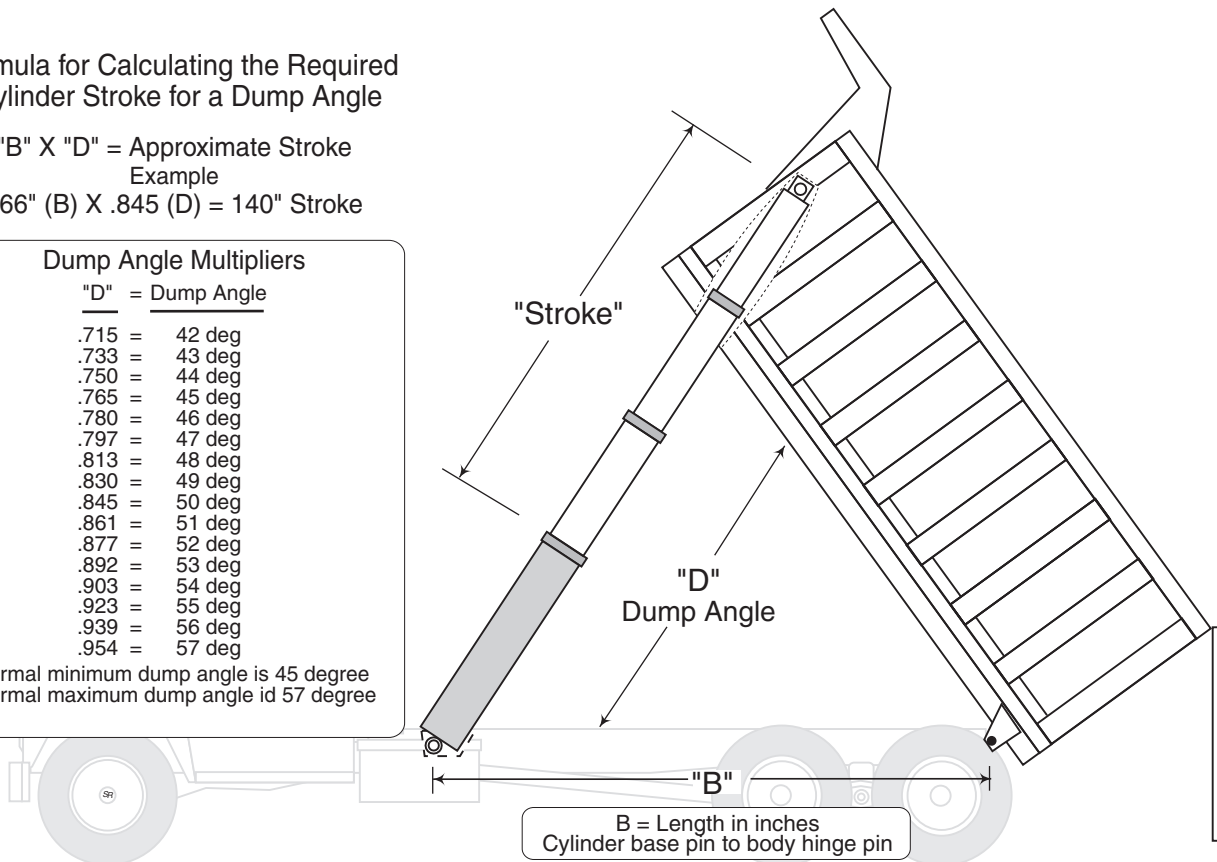

Commodities & Materials Approximate Weights

Approximate Weights of Materials

Material	lbs. / cu. yd.	tons / cu. yd.	Material	lbs. / cu. yd.	tons / cu. yd.
Andesite stone	4887	2.44	Earth & sand, wet	3240	1.62
Ashes	1080	0.52	Fire Brick	3915	1.95
Asphalt	2700	1.35	Fire Clay	3510	1.75
Asphaltum	2349	1.17	Garbage	1150	0.57
Basalt rock	4887	2.44	Gravel, dry	2970	1.48
Brick, soft clay	2718	1.35	Gravel, out of water	1620	0.81
Brick, hard clay	3397	1.69	Granite	4536	2.26
Brick, pressed	3806	1.9	Lime, quick, loose	1431	0.71
Brick, paving	4246	2.12	Lime, quick, shaken	1485	0.70
Block, paving	3694	1.84	Limestone, solid	4536	2.26
Bluestone	2970	1.48	Limestone, loose	2592	1.29
Cement, natural	1512	0.75	Marble, solid	4455	2.22
Cement, Portland	2430	1.21	Marble, loose	2592	1.29
Cement, Portland, set	4941	2.47	Mortar, set	2781	1.39
Cement, Rosendale	1863	0.93	Mud, dry	2430	1.21
Cinders	1080	0.54	Mud, packed	3105	1.55
Clay, dry	1701	0.85	Mud, wet	2916	1.45
Clay, wet	2970	1.48	Pitch	1863	0.93
Clay & gravel, dry	2700	1.35	Plaster of Paris	2646	1.32
Coal, anthracite	1536	0.76	Powder, blasting	1682	0.84
Coal, bituminous	1275	0.64	Quartz	4374	2.18
Coke	837	0.42	Rubbish	199.8	0.09
Concrete, cinders	2970	1.48	Sand, dry, loose	2619	1.30
Concrete, gravel	4104	2.05	Sand, wet	3186	1.59
Concrete, limestone	4050	2.02	Sandstone	4023	2.01
Concrete, sandstone	3915	1.95	Slag, bank	1890	0.94
Concrete, trap rock	4185	2.09	Slag, screenings	2700	1.35
Crushed stone	2700	1.35	Slag, machine	2592	1.29
Earth, dry, loose	1890	0.94	Slag, sand	1485	0.74
Earth, damp, loose	2106	1.05	Shale	4374	2.18
Earth, damp packed	2592	1.29	Slate	4725	2.31
Earth & gravel, dry	2700	1.35	Tar	1674	0.83
Earth & gravel, wet	3240	1.62	Tile	2970	1.43
Earth & sand, dry	2709	1.35	Trap stone	5849	2.52

Steel & Aluminum Gauge, Thickness and Weight

Steel

3/8"	0.375	15.320 lbs. per sq. ft.
1/4" (approx. 3 Ga.)	0.250	10.200 lbs. per sq. ft.
3/16" (approx. 7 Ga.)	0.188	7.650 lbs. per sq. ft.
8 Ga.	0.164	6.875 lbs. per sq. ft.
9 Ga.	0.149	6.250 lbs. per sq. ft.
10 Ga.	0.134	5.625 lbs. per sq. ft.
11 Ga.	0.120	5.000 lbs. per sq. ft.
12 Ga.	0.105	4.375 lbs. per sq. ft.
13 Ga.	0.090	3.750 lbs. per sq. ft.
14 Ga.	0.075	3.125 lbs. per sq. ft.

Aluminum

3/8"	0.375	5.18 lbs. per sq. ft.
1/4"	0.250	3.53 lbs. per sq. ft.
3/16"	0.188	2.65 lbs. per sq. ft.
5/32"	0.156	2.25 lbs. per sq. ft.

Dump Hoist Type Identification Chart

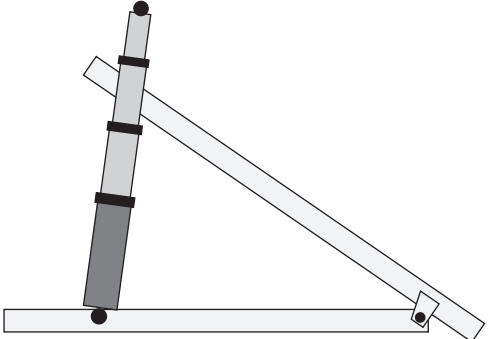

FRONT MOUNT TELESCOPIC
HEAD LIFT OR BOTTOM LIFT

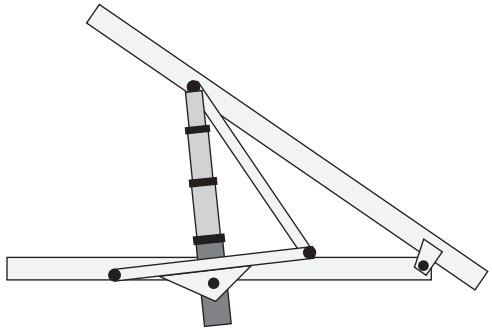

TELESCOPIC SCISSOR
HINGE FORWARD OR REARWARD

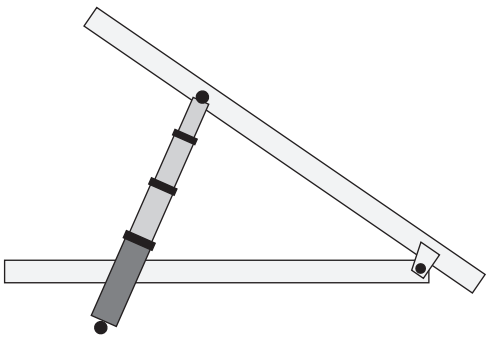

UNDERBODY TELESCOPIC
SLANT FORWARD OR SLANT REARWARD

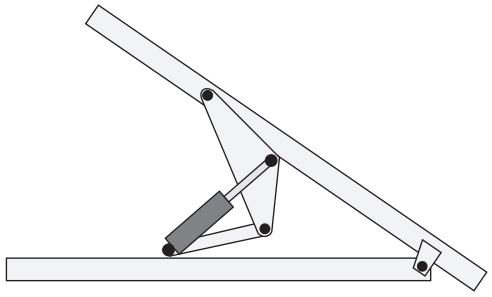

SINGLE STAGE SCISSOR

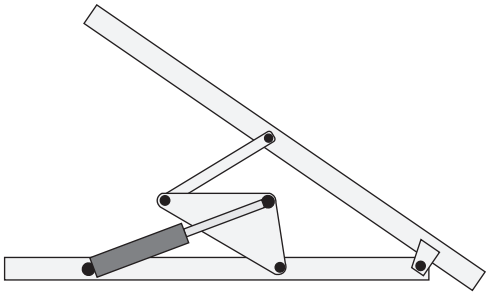

UNDER BODY ARM HOIST

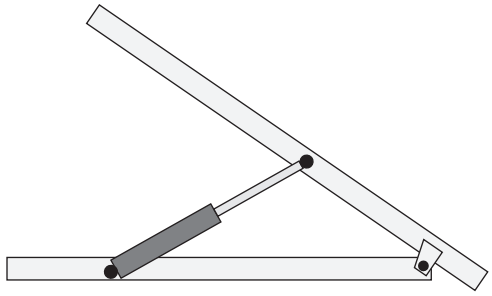

UNDER BODY DIRECT LIFT

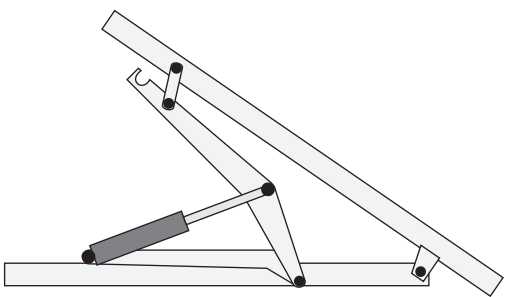

UNDER BODY ARM - SCISSOR

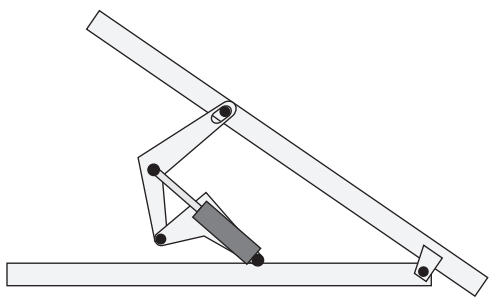

LOST MOTION SCISSOR

Dump Trailer Type Identification Chart

FRAME TYPE

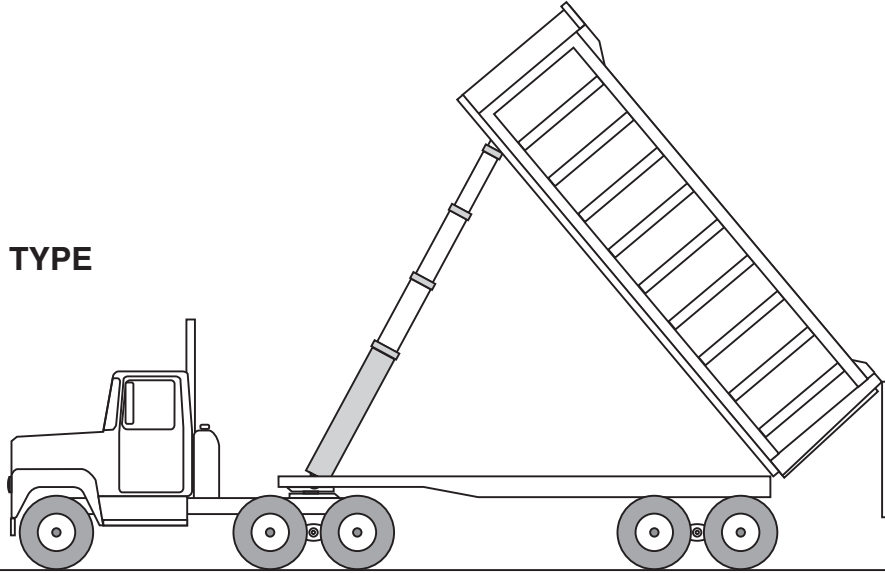

FRAMELESS

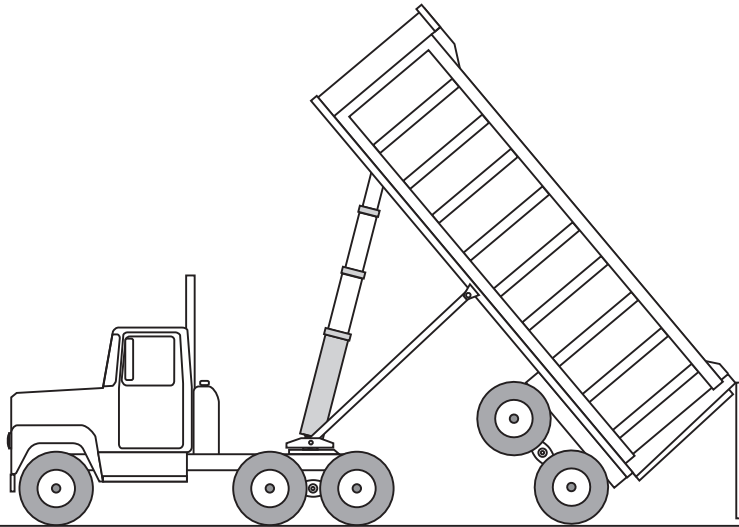

FRAMELESS HYBRID

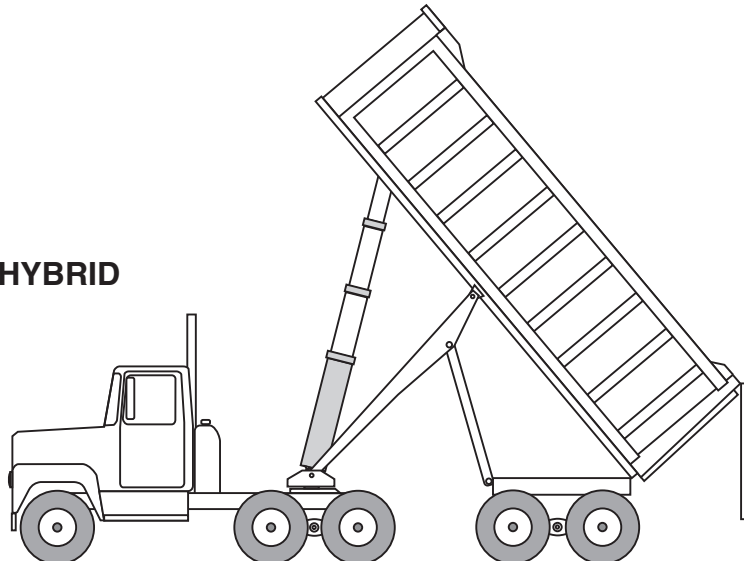

Single-Acting Telescopic Cylinders With CC, DB, and DC Mounts

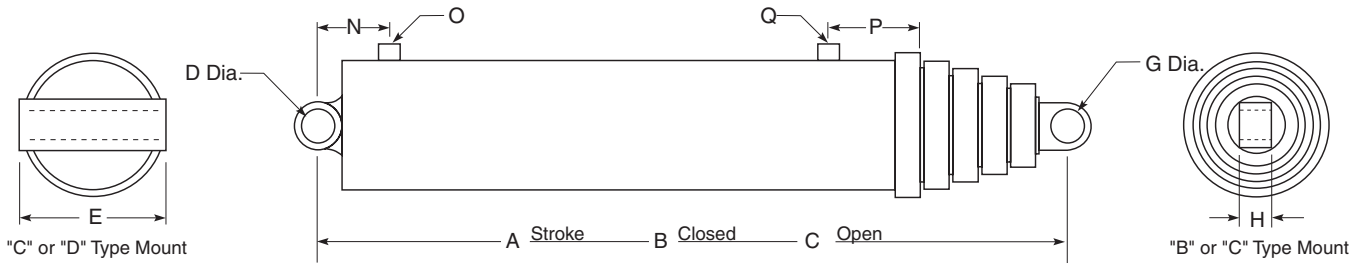

ENGINEERING NUMBER	10 DIGIT NUMBER	NOMINAL STAGE OD	NUMBER STAGES	A STROKE	B CLOSED	C OPEN	D PIN	E WIDTH	G PIN	H WIDTH
S42CC-19-40	3771012052	4	2	40.00	32.44	72.44	1.50	2.00	1.50	2.00
S43DB-3-75	3781013005	4	3	75.00	33.88	108.88	2.00	5.00	1.25	1.69
S52CC-41-54.62	3771512092	5	2	54.62	38.00	92.62	2.50	3.62	2.50	3.62
S52CC-41-67.25	3771512091	5	2	67.25	46.81	114.06	2.50	3.62	2.50	3.62
S52DB-9-67.50	3771512080	5	2	67.50	46.75	114.25	3.00	5.50	2.00	3.00
S53DB-13-60	3781513005	5	3	60.00	30.00	90.00	2.00	6.00	1.50	2.63
S53DB-18-90	3781513008	5	3	90.00	39.75	129.75	2.00	6.00	1.50	2.63
S53DC-65-104	3771513168	5	3	104.00	47.69	151.69	2.00	7.00	1.75	2.00
S53DC-65-107	3771513169	5	3	107.56	48.38	155.94	2.00	7.00	1.75	2.00
S53DC-65-120	3771513166	5	3	120.13	53.06	173.19	2.00	7.00	1.75	2.00
S53DC-65-126	3771513170	5	3	126.63	54.56	181.19	2.00	7.00	1.75	2.00
S53DC-66-72	3771513172	5	3	72.00	37.19	109.19	2.00	7.00	1.63	1.50
S53DC-66-84	3771513171	5	3	84.00	41.19	125.19	2.00	7.00	1.63	1.50
S53DC-68-105	3771513176	5	3	105.00	48.50	153.50	2.00	7.75	1.75	1.50
S53DC-68-120	3771513177	5	3	120.00	52.50	172.50	2.00	7.75	1.75	1.50
S53DC-68-123	3771513178	5	3	123.00	54.50	177.50	2.00	7.75	1.75	1.50
S53DC-68-99	3771513175	5	3	99.00	46.50	145.50	2.00	7.75	1.75	1.50
S63DC-101-104	3771413319	6	3	103.94	47.00	150.94	2.00	7.00	2.00	2.00
S63DC-101-107	3771413320	6	3	107.56	48.38	155.94	2.00	7.00	2.00	2.00
S63DC-101-120	3771413321	6	3	120.06	52.62	172.68	2.00	7.00	2.00	2.00
S63DC-101-126	3771413322	6	3	126.31	54.56	180.87	2.00	7.00	2.00	2.00
S63DC-101-140	3771413324	6	3	140.25	59.81	200.06	2.00	7.00	2.00	2.00
S63DC-101-150	3771413318	6	3	149.88	63.00	212.88	2.00	7.00	2.00	2.00
S63DC-101-86	3771413316	6	3	86.75	40.88	127.63	2.00	7.00	2.00	2.00
S63DC-101-92	3771413317	6	3	92.00	45.00	137.00	2.00	7.00	2.00	2.00
S63DC-102-120	3771413325	6	3	120.00	53.50	173.50	2.38	8.00	2.19	1.50
S63DC-102-126	3771413326	6	3	126.00	55.50	181.50	2.38	8.00	2.19	1.50
S63DC-102-138	3771413327	6	3	138.00	59.50	197.50	2.38	8.00	2.19	1.50
S63DC-102-150	3771413328	6	3	150.00	66.00	216.00	2.38	8.00	2.19	1.50
S63DC-102-162	3771413329	6	3	162.00	67.50	229.50	2.38	8.00	2.19	1.50
S63DC-79-67	3771413260	5	3	67.00	36.50	103.50	3.00	7.88	1.75	1.50
S63DC-96-130	3771413308	6	3	130.00	56.00	186.00	2.00	7.00	2.00	2.00
S63DC-96-82.50	3771413306	6	3	82.50	43.56	126.06	2.00	7.00	2.00	2.00
S63DC-97-111	3771413309	6	3	111.00	49.94	160.94	2.00	7.00	2.00	2.00
S63DC-97-123	3771413310	6	3	123.00	54.94	177.94	2.00	7.00	2.00	2.00

Note; Diameters D and G are for nominal pin size, for actual hole size refer to print.

Note; Nominal Stage OD, refers to the Largest Moving Sleeve.

Single-Acting Telescopic Cylinders With CC, DB, and DC Mounts

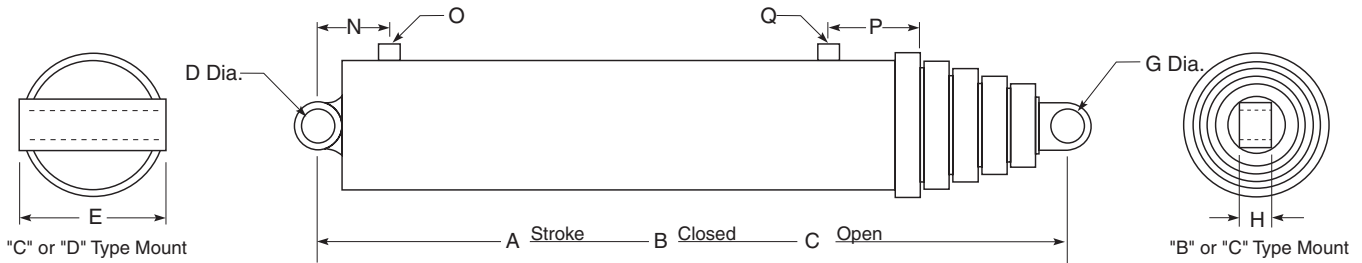

10 DIGIT NUMBER	N LOCATION	O SIZE	P LOCATION	Q SIZE	GALS TO FILL	GALS TO EXTEND	WEIGHT LBS	REBUILD KIT	REPACK KIT
3771012052	14"	1/2" NPT			2.07	2.46	52	3751805175	3751805174
3781013005			19"	1/2" NPT	0.77	2.11	85	3751805720	3751804368
3771512092	3.88"	#8 SAE			2	3.4	120	3751805581	3751805580
3771512091	3.88"	#8 SAE			2.51	4.17	145	3751805581	3751805580
3771512080	20"	#12 SAE			2.42	4.2	135	3751805581	3751805580
3781513005			19"	1/2" NPT	1.7	3	120	3751804017	3911804020
3781513008			19"	3/4" NPT	1.22	4.45	200	3751804017	3911804020
3771513168			15.50"	1" NPT	2.4	5.89	175	3751804017	3911804020
3771513169			9.94"	1" NPT	2.4	5.89	178	3751804017	3911804020
3771513166			15.50"	1" NPT	2.42	5.9	195	3751804017	3911804020
3771513170			16.12"	1" NPT	2.42	5.9	205	3751804017	3911804020
3771513172	19.50"	3/4" NPT			1.8	3.5	165	3751804017	3911804020
3771513171	19.50"	3/4" NPT			1.8	3.5	170	3751804017	3911804020
3771513176	24.81"	#16 90D SAE			2	5.2	170	3751804017	3911804020
3771513177	24.81"	#16 90D SAE			1.62	5.9	220	3751804017	3911804020
3771513178	24.81"	#16 90D SAE			2.8	6.1	232	3751804017	3911804020
3771513175	24.81"	#16 90D SAE			1.95	4.87	165	3751804017	3911804020
3771413319	20.81"	1" NPT			1.75	8.05	250	3751804018	3911804109
3771413320	20.81"	1" NPT			1.82	8.37	256	3751804018	3911804109
3771413321	20.81"	1" NPT			2.03	9.33	275	3751804018	3911804109
3771413322	20.81"	1" NPT			2.13	9.84	285	3751804018	3911804109
3771413324	20.81"	1" NPT			2.37	10.94	310	3751804018	3911804109
3771413318	20.81"	1" NPT			2.53	11.71	325	3751804018	3911804109
3771413316	20.81"	1" NPT			1.47	6.79	225	3751804018	3911804109
3771413317	20.81"	1" NPT			1.56	7.14	195	3751804018	3911804109
3771413325	24.91"	#16 90D SAE			2.02	9.4	270	3751804018	3911804109
3771413326	24.91"	#16 90D SAE			2.13	9.9	275	3751804018	3911804109
3771413327	24.91"	#16 90D SAE			2.33	11.1	300	3751804018	3911804109
3771413328	24.91"	#16 90D SAE			2.54	11.9	330	3751804018	3911804109
3771413329	24.91"	#16 90D SAE			2.75	12.64	330	3751804018	3911804109
3771413260	20.50"	3/4" NPT			2.18	5.12	180	3751805654	3751805594
3771413308	20.81"	1" 90D NPT			2.15	10.85	295	3751804018	3911804109
3771413306	20.81"	1" 90D NPT			2.15	10.85	230	3751804018	3911804109
3771413309	3.81"	1" NPT	24"	1" NPT	1.87	8.61	270	3751804018	3911804109
3771413310	3.81"	1" NPT	29"	1" NPT	2.08	9.63	285	3751804018	3911804109

Note; Diameters D and G are for nominal pin size, for actual hole size refer to print.

Note; Nominal Stage OD, refers to the Largest Moving Sleeve.

Single-Acting Telescopic Cylinders With CC, DB, and DC Mounts

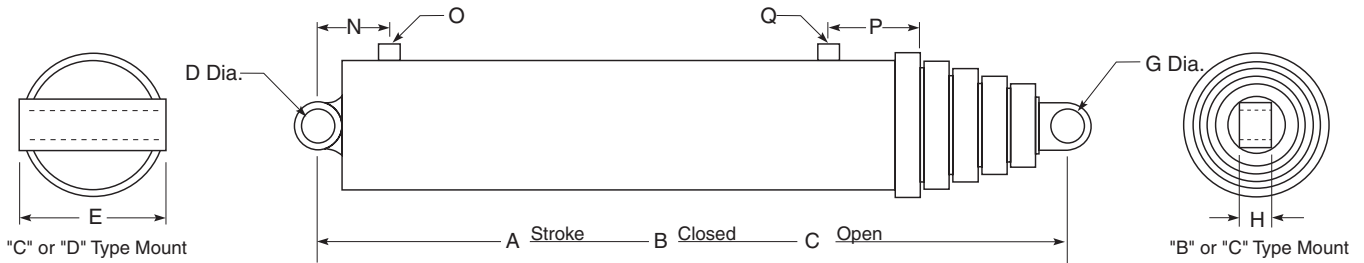

ENGINEERING NUMBER	10 DIGIT NUMBER	NOMINAL STAGE OD	NUMBER STAGES	A STROKE	B CLOSED	C OPEN	D PIN	E WIDTH	G PIN	H WIDTH
S64DB-12-135	3771414058	6	4	135.00	47.19	182.19	1.75	8.00	1.50	2.69
S64DB-12-156	3771414056	6	4	156.00	53.19	209.19	1.75	8.00	1.50	2.69
S64DC-14-156	3771414059	6	4	156.00	53.62	209.62	2.00	7.25	2.00	1.75
S64DC-15-157	3771414061	6	4	157.00	58.56	215.56	1.50	7.00	1.50	2.00
S73DC-66-110	3772513127	7	3	110.63	50.06	160.69	2.00	8.25	2.00	2.00
S73DC-66-120	3772513132	7	3	120.00	53.12	173.12	2.00	8.25	2.00	2.00
S73DC-66-124	3772513128	7	3	124.88	54.81	179.69	2.00	8.25	2.00	2.00
S73DC-66-129	3772513135	7	3	129.00	56.50	185.50	2.00	8.25	2.00	2.00
S73DC-66-140	3772513129	7	3	140.44	60.00	200.44	2.00	8.25	2.00	2.00
S73DC-66-150	3772513131	7	3	150.00	63.50	213.50	2.00	8.25	2.00	2.00
S74DC-74-120	3772514124	7	4	120.00	44.12	164.12	2.00	8.25	2.00	2.00
S74DC-74-135	3772514125	7	4	135.00	48.44	183.44	2.00	8.25	2.00	2.00
S74DC-74-140	3772514122	7	4	140.00	49.75	189.75	2.00	8.25	2.00	2.00
S74DC-74-156	3772514123	7	4	156.00	53.75	209.75	2.00	8.25	2.00	2.00
S74DC-74-161	3772514120	7	4	161.75	55.31	217.06	2.00	8.25	2.00	2.00
S74DC-74-180	3772514126	7	4	180.00	61.12	241.12	2.00	8.25	2.00	2.00
S84DC-40-170	3772914050	8	4	170.00	57.25	227.25	2.00	9.50	2.00	2.00
S84DC-66-140	3772914080	8	4	140.00	49.75	189.75	2.00	9.50	2.00	2.00
S84DC-66-148	3772914081	8	4	147.75	51.50	199.25	2.00	9.50	2.00	2.00
S84DC-66-156	3772914086	8	4	156.00	53.75	209.75	2.00	9.50	2.00	2.00
S84DC-66-161	3772914082	8	4	160.00	55.75	215.75	2.00	9.50	2.00	2.00
S84DC-66-170	3772914083	8	4	170.00	57.25	227.25	2.00	9.50	2.00	2.00
S84DC-66-180	3772914084	8	4	180.00	59.75	239.75	2.00	9.50	2.00	2.00
S84DC-66-188	3772914085	8	4	188.00	61.75	249.75	2.00	9.50	2.00	2.00
S85DC-66-170	3772915164	8	5	170.00	49.88	219.88	2.00	9.50	2.00	2.00
S85DC-66-190	3772915166	8	5	189.00	54.62	243.62	2.00	9.50	2.00	2.00
S85DC-66-197	3772915162	8	5	196.13	55.25	251.38	2.00	9.50	2.00	2.00
S85DC-66-220	3772915167	8	5	219.00	60.00	279.00	2.00	9.50	2.00	2.00
S85DC-66-235	3772915161	8	5	234.00	64.62	298.62	2.00	9.50	2.00	2.00
S85DC-66-250	3772915160	8	5	249.00	68.62	317.62	2.00	9.50	2.00	2.00
S85DC-66-265	3772915165	8	5	265.00	71.00	336.00	2.00	9.50	2.00	2.00
S85DC-66-285	3772915163	8	5	285.00	78.50	363.50	2.00	9.50	2.00	2.00

Note; Diameters D and G are for nominal pin size, for actual hole size refer to print.

Note; Nominal Stage OD, refers to the Largest Moving Sleeve.

Single-Acting Telescopic Cylinders With CC, DB, and DC Mounts

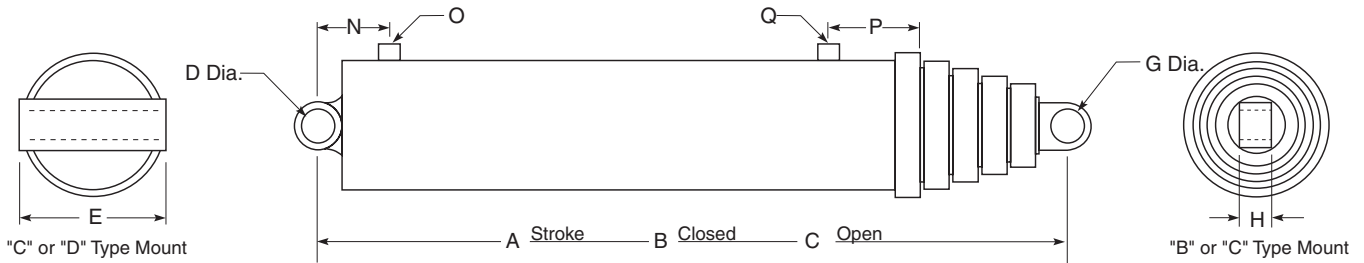

10 DIGIT NUMBER	N LOCATION	O SIZE	P LOCATION	Q SIZE	GALS TO FILL	GALS TO EXTEND	WEIGHT LBS	REBUILD KIT	REPACK KIT
3771414058			5.50"	2, 3/4" NPT	2.6	8.1	275	3751804021	3911804237
3771414056			5.50"	2, 3/4" NPT	3.2	10.1	293	3751804021	3911804237
3771414059	6.31"	1" NPT			2.5	10.01	310	3751804021	3911804237
3771414061	4.31"	1" NPT			3.8	9.5	310	3751804021	3911804237
3772513127	7.06"	1" NPT	4.62"	1" NPT	2.34	12.6	335	3751804019	3751804002
3772513132	7.06"	1" NPT	4.62"	1" NPT	2.4	13.5	360	3751804019	3751804002
3772513128	7.06"	1" NPT	4.62"	1" NPT	2.53	14.2	370	3751804019	3751804002
3772513135	8.56"	1" NPT	4.62"	1" NPT	2.6	14.7	385	3751804019	3751804002
3772513129	7.06"	1" NPT	4.62"	1" NPT	2.84	16.1	400	3751804019	3751804002
3772513131	7.06"	1" NPT	4.62"	1" NPT	3.1	17.1	420	3751804019	3751804002
3772514124	7.06"	1" NPT	4.62"	1" NPT	2.2	11.5	325	3751804022	3751804003
3772514125	7.06"	1" NPT	4.62"	1" NPT	2.5	13	375	3751804022	3751804003
3772514122	7.06"	1" NPT	4.62"	1" NPT	2.6	13.5	365	3751804022	3751804003
3772514123	7.06"	1" NPT	4.62"	1" NPT	2.9	15.1	388	3751804022	3751804003
3772514120	7.06"	1" NPT	4.62"	1" NPT	4.48	15.5	405	3751804022	3751804003
3772514126	7.06"	1" NPT	4.62"	1" NPT	3.5	17.4	430	3751804022	3751804003
3772914050	6.50"	1" NPT	5.62"	1" NPT	7.6	23.3	570	3751804023	3911804054
3772914080	6.50"	1" NPT	5.62"	1" NPT	3	19.1	488	3751804023	3911804054
3772914081	6.50"	1" NPT	5.62"	1" NPT	3.2	20.2	515	3751804023	3911804054
3772914086	5.56"	1" NPT	5.62"	1" NPT	3.4	21.3	535	3751804023	3911804054
3772914082	6.50"	1" NPT	5.62"	1" NPT	3.5	22	555	3751804023	3911804054
3772914083	6.50"	1" NPT	5.62"	1" NPT	3.7	23.4	568	3751804023	3911804054
3772914084	6.50"	1" NPT	5.62"	1" NPT	3.9	24.7	591	3751804023	3911804054
3772914085	6.50"	1" NPT	5.62"	1" NPT	4.1	25.8	610	3751804023	3911804054
3772915164	6.50"	1" NPT	5.62"	1" NPT	3.4	20	516	3751804024	3911804060
3772915166	6.50"	1" NPT	5.62"	1" NPT	3.8	22.3	555	3751804024	3911804060
3772915162	6.50"	1" NPT	5.62"	1" NPT	3.9	23.1	560	3751804024	3911804060
3772915167	6.50"	1" NPT	5.62"	1" NPT	4.4	25.9	565	3751804024	3911804060
3772915161	6.50"	1" NPT	5.62"	1" NPT	4.7	27.7	650	3751804024	3911804060
3772915160	6.50"	1" NPT	5.62"	1" NPT	5	29.5	685	3751804024	3911804060
3772915165	6.50"	1" NPT	5.62"	1" NPT	5.3	31.5	715	3751804024	3911804060
3772915163	6.50"	1" NPT	5.62"	1" NPT	5.7	34	795	3751804024	3911804060

Note; Diameters D and G are for nominal pin size, for actual hole size refer to print.
Note; Nominal Stage OD, refers to the Largest Moving Sleeve.

Single-Acting Telescopic Cylinders With CC, DB, and DC Mounts

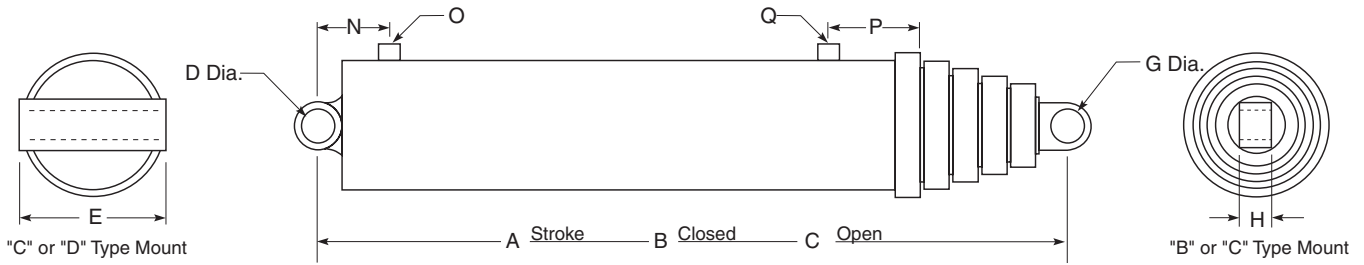

ENGINEERING NUMBER	10 DIGIT NUMBER	NOMINAL STAGE OD	NUMBER STAGES	A STROKE	B CLOSED	C OPEN	D PIN	E WIDTH	G PIN	H WIDTH
S95DC-52-190	3773115068	9	5	190.00	56.00	246.00	2.00	10.88	2.00	2.00
S95DC-52-220	3773115064	9	5	218.00	62.44	280.44	2.00	10.88	2.00	2.00
S95DC-52-235	3773115063	9	5	233.00	65.44	298.44	2.00	10.88	2.00	2.00
S95DC-52-250	3773115061	9	5	248.00	68.44	316.44	2.00	10.88	2.00	2.00
S95DC-52-265	3773115069	9	5	265.00	72.62	337.62	2.00	10.88	2.00	2.00
S95DC-52-280	3773115067	9	5	280.00	78.62	358.62	2.00	10.88	2.00	2.00
S95DC-52-300	3773115066	9	5	300.00	79.00	379.00	2.00	10.88	2.00	2.00
S95DC-52-320	3773115065	9	5	320.00	83.00	403.00	2.00	10.88	2.00	2.00
S95DC-52-340	3773115062	9	5	340.00	87.00	427.00	2.00	10.88	2.00	2.00

Note; Diameters D and G are for nominal pin size, for actual hole size refer to print.

Note; Nominal Stage OD, refers to the Largest Moving Sleeve.

Single-Acting Telescopic Cylinders With CC, DB, and DC Mounts

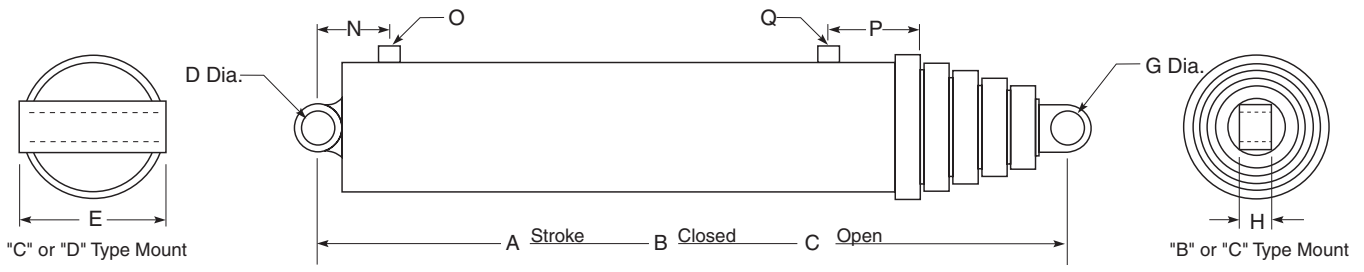

10 DIGIT NUMBER	N LOCATION	O SIZE	P LOCATION	Q SIZE	GALS TO FILL	GALS TO EXTEND	WEIGHT LBS	REBUILD KIT	REPACK KIT
3773115068	6.50"	1" NPT	5.75"	1" NPT	3.9	22.4	835	3751804025	3751804004
3773115064	6.50"	1" NPT	5.75"	1" NPT	6.8	36.2	855	3751804025	3751804004
3773115063	6.50"	1" NPT	5.75"	1" NPT	7.1	38.7	880	3751804025	3751804004
3773115061	6.50"	1" NPT	5.75"	1" NPT	7.5	41.3	1100	3751804025	3751804004
3773115069	6.50"	1" NPT	5.75"	1" NPT	8.2	44.6	1200	3751804025	3751804004
3773115067	6.50"	1" NPT	5.75"	1" NPT	9.3	47.6	1215	3751804025	3751804004
3773115066	6.50"	1" NPT	5.75"	1" NPT	9.6	50.2	1230	3751804025	3751804004
3773115065	6.50"	1" NPT	5.75"	1" NPT	9.8	54.1	1200	3751804025	3751804004
3773115062	12.50"	1" NPT	5.75"	1" NPT	10.2	59.9	1245	3751804025	3751804004

Note; Diameters D and G are for nominal pin size, for actual hole size refer to print.
Note; Nominal Stage OD, refers to the Largest Moving Sleeve.

Single-Acting Telescopic Cylinders With MB and MC Mounts

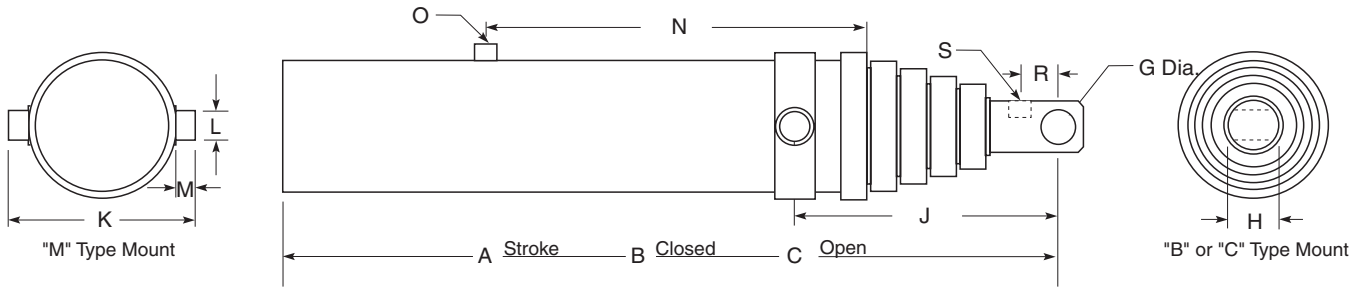

ENGINEERING NUMBER	10 DIGIT NUMBER	NOMINAL STAGE OD	NUMBER STAGES	A STROKE	B CLOSED	C OPEN	G PIN	H WIDTH	J TR to PIN	K WIDTH	L DIA.	M LGTH
S63MB-8-140	3771413124	6	3	140.25	61.62	201.9	1.5	3.62	14.37	12.38	1.8	1.69
S74MB-3-154	3772514058	7	4	154	55.62	209.6	1.5	3.62	14.37	12.25	1.8	1.63
S74MB-3-172	3772514062	7	4	172	58.34	230.3	1.5	3.62	14.37	12.25	1.8	1.63
S85MC-48-200	3772915121	8	5	199	55	254	2	3	15.5	14	2.3	1.25
S85MC-48-220	3772915122	8	5	219	59	278	2	3	15.5	14	2.3	1.25
S85MC-48-235	3772915123	8	5	234	65	299	2	3	15.5	14	2.3	1.25
S85MC-48-250	3772915120	8	5	249	67	316	2	3	15.5	14	2.3	1.25
S85MC-48-265	3772915119	8	5	265	71	336	2	3	15.5	14	2.3	1.25
S85MC-48-280	3772915118	8	5	280	78.87	358.9	2	3	15.5	14	2.3	1.25

Note; Bold / Highlighted Items are Standard Warehouse Items.

Note; Diameters G are for nominal pin size, for actual hole size refer to print.

Note; Nominal Stage OD, refers to the Largest Moving Sleeve.

Single-Acting Telescopic Cylinders With MB and MC Mounts

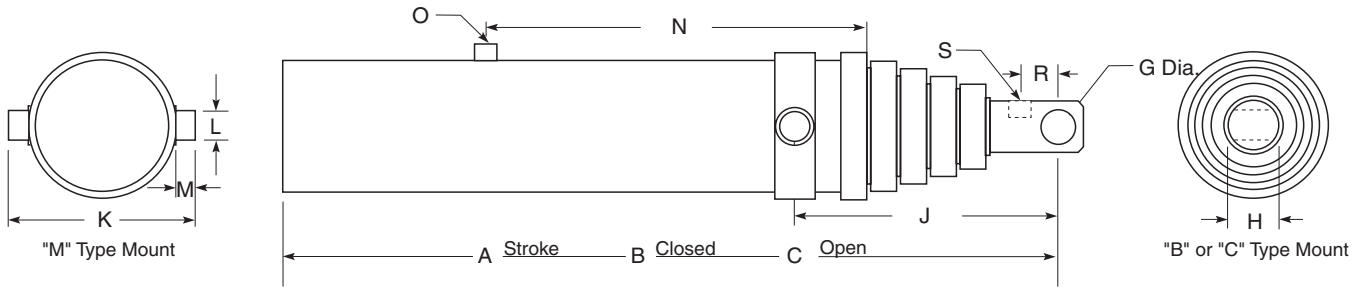

10 DIGIT NUMBER	N LOCATION	O SIZE	R LOCATION	S SIZE	GALS TO FILL	GALS TO EXTEND	WEIGHT LBS	REBUILD KIT	REPACK KIT
3771413124			2"	1" NPT	4.8	11.2	280	3751804018	3911804109
3772514058			2"	1" NPT	5.2	15.1	412	3751804022	3751804003
3772514062			2"	1" NPT	5.6	16.6	436	3751804022	3751804003
3772915121			2"	1" NPT	6.4	23.5	620	3751804024	3911804060
3772915122			2"	1" NPT	7.1	26.1	640	3751804024	3911804060
3772915123			2"	1" NPT	7.8	27.2	670	3751804024	3911804060
3772915120			2"	1" NPT	8.4	29.1	720	3751804024	3911804060
3772915119			2"	1" NPT	8.7	31.6	780	3751804024	3911804060
3772915118			2"	1" NPT	9.8	34.1	800	3751804024	3911804060

Note; Bold / Highlighted Items are Standard Warehouse Items.
 Note; Diameters G are for nominal pin size, for actual hole size refer to print.
 Note; Nominal Stage OD, refers to the Largest Moving Sleeve.

Quick Reference Guide

Accurate

HH-1	D62LB-5-80
HH-2	D72LB-9-80
HP-HH001	D62LB-5-80
HP-HH002	D72LB-9-80
MF-51	D72LB-9-80

Anthony Midwest Body

H070105	S63DC-97-111 CM26
H0701052	S63DC-97-111 CM26
H0710432	S73DC-66-110 CM26
H075018	S73DC-66-124 CM23
H0750182	S73DC-66-124 CM26
H130409	S63DC-101-140 CM26

Beall

A3602	S53DC-65-126
A3660	S63DC-101-140

Benton Harbor

A89646	D70LN-5-90
P89645	D70LN-5-80
P89648	D60DB-23-72

Bme Engineering Co

P-60-OR-176T Hoist	SD63CB-23-118
--------------------	---------------

Caterpillar

246-7145	S84DC-66-140
246-7332	S63MB-8-140
246-7359	S85MC-48-250
246-7444	S73DC-66-140
246-7456	S74DC-74-156
246-7564	S63DC-97-123
246-7594	S64DB-12-135

Commercial / Parker

3782000014	3782000014
B4079	D35LD-7-16
B4100	D25LD-2-90
B4103	D45CC-19-41.50
B4388	D20DD-8-95
B4777	D30CD-13-28
B5109	D40CB-10-42
B5162	D30CC-17-28.19
B5420	D62LB-5-80
B5429	D20DD-6-6.25
B5489	D50DD-28-39.50
B5501	D35DD-7-17.88
B5546	D25LL-14-42
B5548	D40CL-13-45.38
B5550	D45LD-7-45.38
B5551	D35LD-5-19
B5609	D40MD-1-72
B5642	D30LD-10-36
B5653	D30CC-19-16.00
B5654	D30CC-20-8.00
B5655	D30CC-18-8.00
B5788	D45CC-20-46
B5790	D25LL-15-84
B5799	D17AE-2-71.88
B5845	D70DD-9-79
B5866	D30CE-11-18.50
B5873	D50CC-25-43
B5947	D40DD-19-22.50
B6044	B6044
B6148	D35CC-28-38
B6151	D20DD-8-95
B6231	D45DD-10-52.75
C3805	D50CB-8-27
C3810	D60CD-5-34
C3814	D60CD-5-34
C3865	D40DB-7-28.5
C3870	D60DC-12-42.62
C3872	D50CC-27-36
C3878	D55CC-10-24.25
C3880	D60DD-20-79
C3881	D70DD-9-79
C3882	D60CF-3-32.38

Commercial / Parker

C3884	S41LC-1-39.38
C3919	D45CD-5-49.12
C3926	D40CD-8-22
C4101	D40CD-14-25
C4208	D32LL-11-38
C4435	D30LD-8-33.38
C4444	D60DB-23-72
C4497	D32LL-11-38
C4622	D45CC-19-41.50
C4774	D65CC-9-66
C4793	D55CC-6-63
C5220	D32LL-11-38
D20DD-4-6.25	D20DD-6-6.25
D20DD-6-6.25	D20DD-6-6.25
D30CD-10-28	D30CD-13-28
D30LD-2-33.38	D30LD-8-33.38
D30LD-7-33.38	D30LD-8-33.38
D35CC-16-26	D35CC-27-26
D35DD-1-17.88	D35DD-7-17.88
D35LC-2-2.00	3782000014
D4094	D60BC-5-30.31 495
D40CB-7-42	D40CB-10-42
D40CD-16-29.50	D40CD-16-29.50
D40CD-8-22	D40CD-8-22
D40CL-2-39.38	S41LC-1-39.38
D40DB-3-25.62	D40DB-7-25.62
D40DB-3-28.5	D40DB-7-28.5
D40DB-4-25.62	D40DB-7-25.62
D40DB-6-25.62	D40DB-7-25.62
D40DB-6-28.5	D40DB-7-28.5
D40LD-3-24.75	D40LD-10-24.75
D40LD-5-24.75	D40LD-11-24.75
D40MD-1-72	D40MD-1-72
D4145	SD53CC-48-164
D4171	D55DD-14-38.62
D4172	D50DD-29-25.62
D4190	S31CB-2-42
D4210	D60DC-13-65.75
D4265	D50DD-30-32.50
D4266	D45DD-9-23
D4398	D35CC-27-26
D4434	D45CD-5-49.12
D4482	D55CC-12-49.12
D4496	D45CC-20-46
D4541	D50DD-32-37.25
D45CC-15-41.50	D45CC-19-41.50
D45CD-1-49.13	D45CD-5-49.12
D45CD-2-49.12	D45CD-4-49.12
D45CD-3-49.12	D45CD-5-49.12
D50DD-24-39.50	D50DD-28-39.50
D55CC-1-49.13	D55CC-12-49.12
D55CC-3-49.13	D55CC-12-49.12
D60BC-2-30.31	D60BC-5-30.31
D60BC-3-30.31	D60BC-5-30.31
D60BC-4-30.31	D60BC-5-30.31
D60BC-5-30.31	D60BC-5-30.31
D60DB-4-72	D60DB-23-72
D60DB-7-72	D60DB-23-72
D60DC-10-30.50	D60BC-5-30.31 495
D60DC-11-30.50	D60BC-5-30.31 536
D60DC-1-42.62	D60DC-12-42.62
D60DC-7-42.62	D60DC-12-42.62
D60DD-11-79	D60DD-20-79
D60DD-14-79	D60DD-20-79
D60DD-16-79	D60DD-20-79
D60DD-20-79	D60DD-20-79
D62DB-7-72	D60DB-23-72
D62DC-10-30	D60BC-5-30.31 495
D62LB-2-81	D62LB-5-80
D62LB-3-79	D62LB-5-80
D62LB-3-80	D62LB-5-80
D62LB-4-80	D62LB-5-80
D62LB-5-80	D62LB-5-80
D62MT-2-80	D62LB-5-80
D65CC-10-66	D65CC-9-66
D70DD-5-79	D70DD-9-79
D70DD-6-79	D70DD-9-79
D70DD-9-79	D70DD-9-79

Commercial / Parker

D70LN-1-80	D70LN-5-80
D70LN-2-80	D70LN-5-80
D70LN-2-90	D70LN-5-90
D70LN-4-80	D70LN-5-80
D72DB-10-79	D70DD-9-79
D72DB-3-25	D72DB-7-25
D72DB-4-25	D72DB-7-25
D72DB-7G-25	D72DB-7-25
D72LB-1-80	D72LB-9-80
D72LB-3-80	D72LB-9-80
D72LB-5-80	D72LB-9-80
D72LB-6-81	D72LB-9-80
D72LB-8-80	D72LB-9-80
D72LP-1-80	D70LN-5-80
D72MI-1-80	D72LB-9-80
D72MT-1-80	D72LB-9-80
D84DA-1-25	D84DB-7-25
D84DB-3-25	D84DB-7-25
D84DB-4-25	D84DB-7-25
D84DB-4-25-1	D84DB-7-25-1
D84DB-5-25	D84DB-7-25
D84DB-5-25-1	D84DB-7-25-1
D84DB-7G-25	D84DB-7-25
D84DB-7G-25-1	D84DB-7-25-1
S32DB-1-43	S32DB-3-42.62
S32DB-1-43 CM72	S32DB-3-42.62 CM72
S32DB-1-50	S32DB-3-50
S32DB-1-50 CM72	S32DB-3-50 CM72
S41CL-2-39.38	S41LC-1-39.38
S42CC-12-40	S42CC-19-40
S42DB-5-43	S42DB-8-43
S42DB-5-43 CM72	S42DB-8-43 CM72
S42DB-5-51	S42DB-8-51
S42DB-5-51 CM72	S42DB-8-51 CM72
S42MB-1-82	S42MB-3-90
S42MB-1-83	S42MB-3-90
S42MB-1-86	S42MB-3-90
S42MB-1-90	S42MB-3-90
S42MB-3-83	S42MB-3-90
S43DB-2-75	S43DB-3-75
S43DB-4-75	S43DB-3-75
S52CC-34-54.62	S52CC-41-54.62
S52CC-34-67.25	S52CC-41-67.25
S52CC-37-54.62	S52CC-41-54.62
S52CC-38-67.25	S52CC-41-67.25
S52DB-11-67.50	S52DB-9-67.50
S53DB-1-103	S53DB-20-103
S53DB-13-90	S53DB-18-90
S53DB-18-60	S53DB-13-60
S53DB-3-75	S53DC-66-72 CM25
S53DB-8-103	S53DB-20-103
S53DC-10-72	S53DC-66-72
S53DC-10-84	S53DC-66-84
S53DC-11-104	S53DC-65-104
S53DC-11-107	S53DC-65-107
S53DC-11-120	S53DC-65-120
S53DC-11-126	S53DC-65-126
S53DC-11-130	S53DC-65-130
S53DC-11G-107	S53DC-65-107
S53DC-11G-126	S53DC-65-126
S53DC-12-104	S53DC-65-104
S53DC-12-120	S53DC-65-120
S53DC-12-130	S53DC-65-130
S53DC-12-84	S53DC-66-84 CM8
S53DC-14-72	S53DC-66-72
S53DC-14-84	S53DC-66-84
S53DC-14G-72	S53DC-66-72
S53DC-14G-84	S53DC-66-84
S53DC-15-105	S53DC-68-105
S53DC-15-120	S53DC-68-120
S53DC-15-123	S53DC-68-123
S53DC-15-99	S53DC-68-99
S53DC-15G-105	S53DC-68-105
S53DC-15G-120	S53DC-68-120
S53DC-15G-123	S53DC-68-123
S53DC-15G-99	S53DC-68-99
S53DC-19-90	S53DB-12-90
S53DC-3-72	S53DC-66-72

Crossover and Application Data is for Reference Purpose Only. No Other Conditions are Expressed or Implied.

Note: It is the Users Responsibility to Verify if the Replacement Cylinder is Interchangeable.

Note: In some applications, modifications may be required for proper cylinder installation.

Quick Reference Guide

Commercial / Parker

S53DC-3-84.....	S53DC-66-84
S53DC-4-107.....	S53DC-65-107
S53DC-4-126.....	S53DC-65-126
S53DC-5-107.....	S53DC-65-107
S53DC-5-126.....	S53DC-65-126
S53DC-60-81.....	S53DC-60-81
S53DC-6-105.....	S53DC-68-105
S53DC-6-120.....	S53DC-68-120
S53DC-6-123.....	S53DC-68-123
S53DC-65-104.....	S53DC-65-104
S53DC-6-99.....	S53DC-68-99
S53DC-8-104.....	S53DC-65-104
S53DC-8-120.....	S53DC-65-120
S53DC-8-130.....	S53DC-65-130
S53DC-8-84.....	S53DC-66-84 CM8
S53DC-9-72.....	S53DC-66-72
S53DC-9-84.....	S53DC-66-84
S53MB-1-120.....	S53MB-3-120
S53MB-3-120.....	S53MB-3-120
S53MB-5-90.....	S53MB-5-90
S62CC-15-69.....	S62CC-32-69
S62CC-30-69.....	S62CC-32-69
S63CC-22-111.....	S63DC-97-111
S63CC-22-123.....	S63DC-97-123
S63CC-22-80.....	S63DC-101-77
S63DC-101-130.....	S63DC-96-130
S63DC-101-82.50.....	S63DC-96-82.50
S63DC-22-111.....	S63DC-97-111
S63DC-22-123.....	S63DC-97-123
S63DC-22-80.....	S63DC-101-77
S63DC-22-87.....	S63DC-101-92
S63DC-22-90.....	S63DC-101-92
S63DC-22-95.....	S63DC-101-104
S63DC-23-108.....	S63DC-97-111
S63DC-23-128.....	S63DC-96-130
S63DC-26-111.....	S63DC-97-111
S63DC-27-111.....	S63DC-97-111 CM9
S63DC-28-120.....	S63DC-101-120 CM45
S63DC-30-111.....	S63DC-97-111
S63DC-30-123.....	S63DC-97-123
S63DC-31-107.....	S63DC-101-107 CM37
S63DC-3-111.....	S63DC-97-111
S63DC-31-126.....	S63DC-97-123 CM37
S63DC-32-120.....	S63DC-102-120
S63DC-32-126.....	S63DC-102-126
S63DC-32-138.....	S63DC-102-138
S63DC-32-162.....	S63DC-102-162
S63DC-33-105.....	S63DC-101-107
S63DC-33-120.....	S63DC-101-120
S63DC-33-132.....	S63DC-96-130
S63DC-34-86.....	S63DC-101-86
S63DC-37-82.....	S63DC-96-82.50
S63DC-41-120.....	S63DC-101-120 CM9
S63DC-41-130.....	S63DC-96-130 CM9
S63DC-41-140.....	S63DC-101-140 CM9
S63DC-44-111.....	S63DC-97-111
S63DC-44-123.....	S63DC-97-123
S63DC-44G-111.....	S63DC-97-111
S63DC-44G-123.....	S63DC-97-123
S63DC-45-120.....	S63DC-102-120
S63DC-45-126.....	S63DC-102-126
S63DC-45-138.....	S63DC-102-138
S63DC-45-150.....	S63DC-102-150
S63DC-45-162.....	S63DC-102-162
S63DC-45G-120.....	S63DC-102-120
S63DC-45G-126.....	S63DC-102-126
S63DC-45G-138.....	S63DC-102-138
S63DC-45G-162.....	S63DC-102-162
S63DC-46-107.....	S63DC-101-107 CM37
S63DC-46-126.....	S63DC-97-123 CM37
S63DC-47-104.....	S63DC-101-104
S63DC-47-107.....	S63DC-101-107
S63DC-47-120.....	S63DC-101-120
S63DC-47-126.....	S63DC-101-126
S63DC-47-130.....	S63DC-96-130
S63DC-47-140.....	S63DC-101-140
S63DC-47-150.....	S63DC-101-150
S63DC-47-77.....	S63DC-101-77

Commercial / Parker

S63DC-47-82.....	S63DC-96-82.50
S63DC-47-86.....	S63DC-101-86
S63DC-47-92.....	S63DC-101-92
S63DC-47G-104.....	S63DC-101-104
S63DC-47G-107.....	S63DC-101-107
S63DC-47G-120.....	S63DC-101-120
S63DC-47G-126.....	S63DC-101-126
S63DC-47G-130.....	S63DC-96-130
S63DC-47G-140.....	S63DC-101-140
S63DC-47G-77.....	S63DC-101-77
S63DC-47G-82.....	S63DC-96-82.50
S63DC-47G-86.....	S63DC-101-86
S63DC-48-120.....	S63DC-101-120
S63DC-48-130.....	S63DC-96-130 CM9
S63DC-48-140.....	S63DC-101-140 CM9
S63DC-50-105.....	S63DC-101-107
S63DC-50-120.....	S63DC-101-120
S63DC-50-132.....	S63DC-96-130
S63DC-52-77.....	S63DC-101-77
S63DC-53-86.....	S63DC-101-86
S63DC-5-82.....	S63DC-96-82.50 CM11
S63DC-66-111.....	S63DC-96-111
S63DC-66-123.....	S63DC-96-130
S63DC-66-130.....	S63DC-96-130
S63DC-66-82.....	S63DC-96-82.50
S63DC-6-82.....	S63DC-96-82.50 CM11
S63DC-72-130.....	S63DC-96-130
S63DC-76-130.....	S63DC-96-130
S63DC-81-111.....	S63DC-96-111
S63DC-81-82.50.....	S63DC-96-82.50
S63DC-83-103.94.....	S63DC-101-104
S63DC-83-107.....	S63DC-101-107
S63DC-83-120.....	S63DC-101-120
S63DC-83-126.....	S63DC-101-126
S63DC-83-130.....	S63DC-96-130
S63DC-83-140.....	S63DC-101-140
S63DC-83-150.....	S63DC-101-150
S63DC-83-77.....	S63DC-101-77
S63DC-83-82.....	S63DC-96-82.50
S63DC-83-86.....	S63DC-101-86
S63DC-83-92.....	S63DC-101-92
S63DC-84-106.....	S63DC-60-106
S63DC-84-125.....	S63DC-60-125
S63DC-84-79.12.....	S63DC-60-79.12
S63DC-84-92.....	S63DC-60-92
S63DC-86-111.....	S63DC-97-111
S63DC-86-123.....	S63DC-97-123
S63DC-87-120.....	S63DC-102-120
S63DC-87-126.....	S63DC-102-126
S63DC-87-138.....	S63DC-102-138
S63DC-87-150.....	S63DC-102-150
S63DC-87-162.....	S63DC-102-162
S63DC-92-67.....	S63DC-79-67
S63MB-11-108.....	S63MB-11-108
S63MB-1-120.....	S63MB-9-120
S63MB-1-140.....	S63MB-8-140
S63MB-2-120.....	S63MB-9-120
S63MB-5-108.....	S63MB-11-108
S63MB-8-120.....	S63MB-9-120
S63MB-8G-140.....	S63MB-8-140
S63MB-9G-120.....	S63MB-9-120
S64DB-1-135.....	S64DB-12-135
S64DB-1-156.....	S64DB-12-156
S64DB-2-135.....	S64DB-12-135
S64DB-2-156.....	S64DB-12-156
S64DB-3-135.....	S64DB-12-135
S64DB-3-156.....	S64DB-12-156
S64DB-4-135.....	S64DB-12-135
S64DB-4-156.....	S64DB-12-156
S64DB-5-135.....	S64DB-12-135
S64DB-5-156.....	S64DB-12-156
S64DB-6-135.....	S64DB-12-135
S64DB-6-156.....	S64DB-12-156
S64DB-6G-135.....	S64DB-12-135
S64DB-6G-156.....	S64DB-12-156
S64DB-6G-156R.....	S64DB-12-156
S64DC-1-157.....	S64DC-15-157
S64DC-13-157.....	S64DC-15-157

Commercial / Parker

S64DC-14-156.....	S64DC-14-156
S64DC-2-157.....	S64DC-15-157
S64DC-4-156.....	S64DC-14-156
S64DC-5-156.....	S64DC-14-156
S64DC-7-157.....	S64DC-15-157
S64DC-7G-157.....	S64DC-15-157
S64DC-9-156.....	S64DC-14-156
S64DC-9G-156.....	S64DC-14-156
S64DD-1-157.....	S64DC-15-157
S64MB-1-140.....	S64MB-4-140
S64MB-4-140.....	S64MB-4-140
S73CC-17-110.....	S73DC-66-110
S73CC-18-119.....	S73DC-66-120 CM38
S73CC-20-119.....	S73DC-66-120 CM11
S73CC-20-124.....	S73DC-66-124 CM11
S73CC-22-110.....	S73DC-66-110
S73CC-22-124.....	S73DC-66-124
S73DC-22-110.....	S73DC-66-110
S73DC-22-124.....	S73DC-66-124
S73DC-30-110.....	S73DC-66-110
S73DC-30-124.....	S73DC-66-124
S73DC-30-129.....	S73DC-66-129
S73DC-30-140.....	S73DC-66-140
S73DC-32-129.....	S73DC-66-129
S73DC-32-140.....	S73DC-66-140
S73DC-35-120.....	S73DC-66-120
S73DC-40-110.....	S73DC-66-110
S73DC-40-120.....	S73DC-66-120
S73DC-40-124.....	S73DC-66-124
S73DC-40-129.....	S73DC-66-129
S73DC-40-140.....	S73DC-66-140
S73DC-40-150.....	S73DC-66-150
S73DC-40G-110.....	S73DC-66-110
S73DC-40G-120.....	S73DC-66-120
S73DC-40G-124.....	S73DC-66-124
S73DC-40G-140.....	S73DC-66-140
S73DC-40G-150.....	S73DC-66-150
S73DC-41-129.....	S73DC-66-129
S73DC-41-140.....	S73DC-66-140
S73DC-41G-129.....	S73DC-66-129
S73DC-60-125.....	S73DC-60-125
S73DC-60-142.....	S73DC-60-142
S74CC-22-120.....	S74DC-74-120
S74CC-22-134.....	S74DC-74-135
S74CC-22-161.....	S74DC-74-161
S74DC-22-120.....	S74DC-74-120
S74DC-22-134.....	S74DC-74-135
S74DC-22-161.....	S74DC-74-161
S74DC-30-120.....	S74DC-74-120
S74DC-30-135.....	S74DC-74-135
S74DC-30-138.....	S74DC-74-135
S74DC-30-140.....	S74DC-74-140
S74DC-30-156.....	S74DC-74-156
S74DC-30-161.....	S74DC-74-161
S74DC-3-134.....	S74DC-74-135
S74DC-32-131.....	S74DC-77-135
S74DC-40-120.....	S74DC-74-120
S74DC-40-135.....	S74DC-74-135
S74DC-40-135-OX.....	S74DC-75-135
S74DC-40-138.....	S74DC-74-135
S74DC-40-140.....	S74DC-74-140
S74DC-40-156.....	S74DC-74-156
S74DC-40-161.....	S74DC-74-161
S74DC-40-167.....	S74DC-74-167
S74DC-40-180.....	S74DC-74-180
S74DC-40A-120.....	S74DC-74-120
S74DC-40A-140.....	S74DC-74-140
S74DC-40AG-120.....	S74DC-74-120
S74DC-40AG-140.....	S74DC-74-140
S74DC-40G-135.....	S74DC-74-135
S74DC-40G-156.....	S74DC-74-156
S74DC-40G-161.....	S74DC-74-161
S74DC-40G-180.....	S74DC-74-180
S74DC-41-135.....	S74DC-77-135
S74DC-42-135.....	S74DC-74-135
S74DC-42-156.....	S74DC-74-156
S74DC-42-161.....	S74DC-74-161
S74DC-51-161.....	S74DC-74-161

Crossover and Application Data is for Reference Purpose Only. No Other Conditions are Expressed or Implied.

Note: It is the Users Responsibility to Verify if the Replacement Cylinder is Interchangeable.

Note: In some applications, modifications may be required for proper cylinder installation.

Quick Reference Guide

Commercial / Parker

S74DC-5-135.....	S74DC-77-135
S74DC-60-165.75.....	S74DC-60-165.75
S74DC-61-135.....	S74DC-75-135
S74DC-6-135.....	S74DC-74-135
S74DC-68-135.....	S74DC-75-135
S74DC-71-161.....	S74DC-74-161
S74DC-72-135.....	S74DC-77-135
S74DC-73-161.....	S74DC-74-161
S74MB-2-154.....	S74MB-3-154
S74MB-3G-154.....	S74MB-3-154
S74MB-3G-172.....	S74MB-3-172
S83DC-26-134.....	S83DC-56-134
S83DC-30-139.....	S83DC-56-139
S83DC-32-139.....	S83DC-56-139
S83DC-33-139.....	S83DC-56-139 CM19
S83DC-40-139.....	S83DC-56-139
S83DC-54-134.62.....	S83DC-56-134
S83DC-6-134.....	S83DC-56-134
S84CC-22-134.....	S84DC-66-140
S84CC-22-149.....	S84DC-66-148
S84CC-22-155.....	S84DC-66-161
S84CC-22-172.....	S84DC-66-180
S84CC-22-183.....	S84DC-66-188
S84CC-23-183.....	S84DC-66-180
S84CC-4-183.....	S84DC-66-188
S84CC-6-134.....	S84DC-66-140
S84CC-6-149.....	S84DC-66-148
S84CC-6-183.....	S84DC-66-180
S84CC-8-166.....	S84DC-66-161 CM38
S84CC-8-183.....	S84DC-66-180 CM38
S84DB-1-186.....	S84DC-66-188 CM22
S84DC-22-134.....	S84DC-66-140
S84DC-22-149.....	S84DC-66-148
S84DC-22-155.....	S84DC-66-161
S84DC-22-161.....	S84DC-66-161
S84DC-22-172.....	S84DC-66-180
S84DC-22-183.....	S84DC-66-180
S84DC-25-134.....	S84DC-66-140
S84DC-25-149.....	S84DC-66-148
S84DC-25-161.....	S84DC-66-161
S84DC-25-183.....	S84DC-66-180
S84DC-30-134.....	S84DC-66-140
S84DC-30-149.....	S84DC-66-148
S84DC-30-161.....	S84DC-66-161
S84DC-30-183.....	S84DC-66-180
S84DC-31-156.....	S84DC-66-156
S84DC-31G-156.....	S84DC-66-156
S84DC-40-134.....	S84DC-66-140
S84DC-40-140.....	S84DC-66-140
S84DC-40-148.....	S84DC-66-148
S84DC-40-149.....	S84DC-66-148
S84DC-40-161.....	S84DC-66-161
S84DC-40-170.....	S84DC-66-170
S84DC-40-180.....	S84DC-66-180
S84DC-40-183.....	S84DC-66-180
S84DC-40-188.....	S84DC-66-188
S84DC-40G-140.....	S84DC-66-140
S84DC-40G-148.....	S84DC-66-148
S84DC-40G-161.....	S84DC-66-161
S84DC-40G-170.....	S84DC-66-170
S84DC-40G-180.....	S84DC-66-180
S84DC-40G-188.....	S84DC-66-188
S84DC-4-134.....	S84DC-66-140
S84DC-4-149.....	S84DC-66-148
S84DC-4-183.....	S84DC-66-188
S84DC-45-134.....	S84DC-66-140
S84DC-45-149.....	S84DC-66-148
S84DC-45-183.....	S84DC-66-180
S84DC-46-134.....	S84DC-66-140
S84DC-46-149.....	S84DC-66-148
S84DC-46-183.....	S84DC-66-180
S84DC-47-148.....	S84DC-66-148
S84DC-7-183.....	S84DC-66-180
S84DC-8-134.....	S84DC-66-140
S84DC-8-149.....	S84DC-66-148
S85CB-3-220.....	S85DC-66-220 CM1
S85CC-22-183.....	S85DC-66-190
S85CC-22-190.....	S85DC-66-190

Commercial / Parker

S85CC-22-197.....	S85DC-66-197 CM9
S85CC-22-220.....	S85DC-66-220
S85CC-22-235.....	S85DC-66-235
S85CC-22-250.....	S85DC-66-250
S85CC-23-220.....	S85DC-66-220 CM1
S85CC-23-235.....	S85DC-66-235 CM4
S85CC-24-166.....	S85DC-66-160
S85CC-7-197.....	S85DC-66-197
S85CC-7-220.....	S85DC-66-220
S85CC-8-197.....	S85DC-66-197
S85CC-9-200.....	S85DC-66-197 CM46
S85CC-9-220.....	S85DC-66-220 CM46
S85CC-9-235.....	S85DC-66-235 CM46
S85DB-1-200.....	S85DC-66-197 CM46
S85DB-1-220.....	S85DC-66-220 CM46
S85DB-1-235.....	S85DC-66-235 CM46
S85DB-1-250.....	S85DC-66-250 CM46
S85DB-1-260.....	S85DC-66-265 CM46
S85DB-2-235.....	S85DC-66-235 CM22
S85DB-3-200.....	S85DC-66-197 CM46
S85DB-3-220.....	S85DC-66-220 CM46
S85DB-3-235.....	S85DC-66-235 CM46
S85DB-3-250.....	S85DC-66-250 CM46
S85DB-3-260.....	S85DC-66-265 CM46
S85DC-10-197.....	S85DC-66-197
S85DC-10-220.....	S85DC-66-220
S85DC-12-220.....	S85DC-66-220
S85DC-13-210.....	S85DC-66-220
S85DC-22-176.....	S85DC-66-170
S85DC-22-183.....	S85DC-66-190
S85DC-22-190.....	S85DC-66-190
S85DC-22-197.....	S85DC-66-197
S85DC-22-220.....	S85DC-66-220
S85DC-22-235.....	S85DC-66-235
S85DC-22-250.....	S85DC-66-250
S85DC-23-220.....	S85DC-66-220 CM4
S85DC-23-235.....	S85DC-66-235 CM4
S85DC-25-183.....	S84DC-66-180
S85DC-25-190.....	S85DC-66-190
S85DC-25-250.....	S85DC-66-250
S85DC-30-190.....	S85DC-66-190
S85DC-30-197.....	S85DC-66-197
S85DC-30-220.....	S85DC-66-220
S85DC-30-235.....	S85DC-66-235
S85DC-30-250.....	S85DC-66-250
S85DC-35-190.....	S85DC-66-190
S85DC-35-220.....	S85DC-66-220
S85DC-35-235.....	S85DC-66-235
S85DC-35-250.....	S85DC-66-250
S85DC-36-190.....	S85DC-66-190
S85DC-36-220.....	S85DC-66-220
S85DC-36-235.....	S85DC-66-235
S85DC-36-250.....	S85DC-66-250
S85DC-36-265.....	S85DC-66-265
S85DC-36-280.....	S85DC-66-285
S85DC-40-160.....	S85DC-66-160
S85DC-40-170.....	S85DC-66-170
S85DC-40-190.....	S85DC-66-190
S85DC-40-197.....	S85DC-66-197
S85DC-40-220.....	S85DC-66-220
S85DC-40-235.....	S85DC-66-235
S85DC-40-250.....	S85DC-66-250
S85DC-40-250R.....	S85DC-66-250
S85DC-40-265.....	S85DC-66-265
S85DC-40-285.....	S85DC-66-285
S85DC-40A-220.....	S85DC-66-220
S85DC-40A-265.....	S85DC-66-265
S85DC-40AG-220.....	S85DC-66-220
S85DC-40AG-265.....	S85DC-66-265
S85DC-40G-170.....	S85DC-66-170
S85DC-40G-190.....	S85DC-66-190
S85DC-40G-197.....	S85DC-66-197
S85DC-40G-235.....	S85DC-66-235
S85DC-40G-250.....	S85DC-66-250
S85DC-40G-285.....	S85DC-66-285
S85DC-45-200.....	S85DC-66-197
S85DC-45-220.....	S85DC-66-220
S85DC-45-235.....	S85DC-66-235

Commercial / Parker

S85DC-45-250.....	S85DC-66-250
S85DC-46-200.....	S85DC-66-197
S85DC-46-220.....	S85DC-66-220
S85DC-46-235.....	S85DC-66-235
S85DC-46-250.....	S85DC-66-250
S85DC-47-235.....	S85DC-66-235
S85DC-47-250.....	S85DC-66-250
S85DC-50-190.....	S85DC-66-190
S85DC-50-220.....	S85DC-66-220
S85DC-50-235.....	S85DC-66-235
S85DC-50-250.....	S85DC-66-250
S85DC-50-265.....	S85DC-66-265
S85DC-50-280.....	S85DC-66-285
S85DC-51-160.....	S85DC-66-160
S85DC-51-190.....	S85DC-66-190
S85DC-51-220.....	S85DC-66-220
S85DC-51-235.....	S85DC-66-235
S85DC-51-250.....	S85DC-66-250
S85DC-51-265.....	S85DC-66-265
S85DC-51-285.....	S85DC-66-285
S85DC-5-175.....	S85DC-66-170
S85DC-5-197.....	S85DC-66-197
S85DC-52-190.....	S85DC-66-190
S85DC-5-220.....	S85DC-66-220
S85DC-52-220.....	S85DC-66-220
S85DC-52-235.....	S85DC-66-235
S85DC-52-250.....	S85DC-66-250
S85DC-52-265.....	S85DC-66-265
S85DC-52-280.....	S85DC-66-285
S85DC-54-235.....	S85DC-66-235
S85DC-54-250.....	S85DC-66-250
S85DC-54-265.....	S85DC-66-265
S85DC-55-190.....	S85DC-66-190
S85DC-55-220.....	S85DC-66-220
S85DC-55-235.....	S85DC-66-235
S85DC-55-250.....	S85DC-66-250
S85DC-55-265.....	S85DC-66-265
S85DC-55-280.....	S85DC-66-285
S85DC-56-190.....	S85DC-66-190
S85DC-56-220.....	S85DC-66-220
S85DC-56-235.....	S85DC-66-235
S85DC-56-250.....	S85DC-66-250
S85DC-56-265.....	S85DC-66-265
S85DC-56-280.....	S85DC-66-285
S85DC-59-190.....	S85DC-66-190
S85DC-59-220.....	S85DC-66-220
S85DC-59-235.....	S85DC-66-235
S85DC-59-250.....	S85DC-66-250
S85DC-59-265.....	S85DC-66-265
S85DC-59-285.....	S85DC-66-285
S85DC-59A-265.....	S85DC-66-265
S85DC-61-190.....	S85DC-66-190
S85DC-61-220.....	S85DC-66-220
S85DC-61-235.....	S85DC-66-235
S85DC-61-250.....	S85DC-66-250
S85DC-61-265.....	S85DC-66-265
S85DC-61-285.....	S85DC-66-285
S85DC-64-160.....	S85DC-66-160
S85DC-64-170.....	S85DC-66-170
S85DC-64-190.....	S85DC-66-190
S85DC-64-197.....	S85DC-66-197
S85DC-64-220.....	S85DC-66-220
S85DC-64-235.....	S85DC-66-235
S85DC-64-250.....	S85DC-66-250
S85DC-64-265.....	S85DC-66-265
S85DC-64-285.....	S85DC-66-285
S85DC-7-200.....	S85DC-66-197
S85DC-7-220.....	S85DC-66-220
S85DC-7-235.....	S85DC-66-235
S85DC-7-250.....	S85DC-66-250
S85DC-8-220.....	S85DC-66-220
S85DC-8-235.....	S85DC-66-235
S85MB-2-197.....	S85MC-48-200
S85MB-3-190.....	S85MC-48-200 CM53
S85MB-3-220.....	S85MC-48-220 CM53
S85MC-22-200.....	S85MC-48-200
S85MC-25-220.....	S85MC-48-220
S85MC-3-200.....	S85MC-48-200

Crossover and Application Data is for Reference Purpose Only. No Other Conditions are Expressed or Implied.
Note: It is the Users Responsibility to Verify if the Replacement Cylinder is Interchangeable.
Note: In some applications, modifications may be required for proper cylinder installation.

Quick Reference Guide

Commercial / Parker

S85MC-3-220	S85MC-48-220
S85MC-3-235	S85MC-48-235
S85MC-3-250	S85MC-48-250
S85MC-35-220	S85MC-48-220
S85MC-45-200-15.5	S85MC-48-200
S85MC-45-220-15.5	S85MC-48-220
S85MC-45-235-15.5	S85MC-48-235
S85MC-45-250-15.5	S85MC-48-250
S85MC-46-200-15.5	S85MC-48-200
S85MC-46-220-15.5	S85MC-48-220
S85MC-46-235-15.5	S85MC-48-235
S85MC-46-250-15.5	S85MC-48-250
S85MC-46-265-15.5	S85MC-48-265
S85MC-46-280-15.5	S85MC-48-280
S95CC-22-190	S95DC-52-190 CM4
S95CC-22-220	S95DC-52-220 CM4
S95CC-22-235	S95DC-52-235 CM4
S95CC-22-250	S95DC-52-250 CM4
S95DC-22-190	S95DC-52-190 CM4
S95DC-22-235	S95DC-52-235 CM4
S95DC-22-250	S95DC-52-250 CM4
S95DC-25-190	S95DC-52-190 CM4
S95DC-25-235	S95DC-52-235 CM4
S95DC-25-250	S95DC-52-250 CM4
S95DC-30-220	S95DC-52-220 CM4
S95DC-30-235	S95DC-52-235 CM4
S95DC-30-250	S95DC-52-250 CM4
S95DC-30-300	S95DC-52-300
S95DC-31-260	S95DC-52-265
S95DC-40-190	S95DC-52-190
S95DC-40-210	S95DC-52-220
S95DC-40-220	S95DC-52-220
S95DC-40-235	S95DC-52-235
S95DC-40-250	S95DC-52-250
S95DC-40-265	S95DC-52-265
S95DC-40-280	S95DC-52-280
S95DC-40-285	S95DC-52-285
S95DC-40-300	S95DC-52-300
S95DC-40-320	S95DC-52-320
S95DC-40-340	S95DC-52-340
S95DC-40A-300	S95DC-52-300
S95DC-40A-320	S95DC-52-320
S95DC-40A-340	S95DC-52-340
S95DC-40AG-300	S95DC-52-300
S95DC-40AG-320	S95DC-52-320
S95DC-40G-235	S95DC-52-235
S95DC-40G-250	S95DC-52-250
S95DC-40G-265	S95DC-52-265
S95DC-40G-280	S95DC-52-280
S95DC-41-260	S95DC-52-265
S95DC-43-190	S95DC-53-190
S96DC-1-285	S96DC-2-285
SA53DB-3-110	S53DC-65-107 CM25
SA53DB-3-120	S53DC-65-120 CM25
SA73DC-2-139	S73DC-66-140
SA74DC-3-161	S74DC-74-161
SA83DC-1-139	S83DC-56-139
SA85DC-1-197	S85DC-66-197
SD42CC-10-111	SD42CC-19-111
SD42CC-13-111	SD42CC-19-111
SD42CC-19G-111	SD42CC-19-111
SD42CC-8-111	SD42CC-19-111
SD52CC-19-111	SD52CC-24-111
SD52CC-24G-111	SD52CC-24-111
SD53CC-26-155	SD53CC-36-155
SD53CC-26G-155	SD53CC-36-155
SD53CC-28-182	SD53CC-51-182
SD53CC-31-151	SD53CC-51-151.5
SD53CC-31-182	SD53CC-51-182
SD53CC-31G-182	SD53CC-51-182
SD53CC-32-151.5	SD53CC-51-151.5
SD53CC-32-182	SD53CC-51-182
SD53CC-38-151.5	SD53CC-51-151.5
SD53CC-38-182	SD53CC-51-182
SD53CC-38-182R	SD53CC-51-182
SD53CC-41-151.5	SD53CC-51-151.5
SD53CC-41-182	SD53CC-51-182
SD53CC-41A-151.5	SD53CC-51-151.5

Commercial / Parker

SD53CC-45-164	SD53CC-48-164
SD53CC-CP236-155	SD53CC-36-155
SD53CD-CP510-168	SD53CD-3-168
SD62CB-10-114	SD62CB-12-114
SD62CB-11-114	SD62CB-12-114
SD62DB-1-79	SD62DB-6-79
SD63CB-11-118	SD63CB-23-118
SD63CB-12-132	SD63CB-26-132.75
SD63CB-12-167	SD63CB-26-167
SD63CB-12-167R	SD63CB-26-167
SD63CB-12-197	SD63CB-26-197
SD63CB-13-167	SD63CB-27-167
SD63CB-14-118	SD63CB-23-118
SD63CB-14-118R	SD63CB-23-118
SD63CB-15-132	SD63CB-26-132.75
SD63CB-15-167	SD63CB-26-167
SD63CB-15-197	SD63CB-26-197
SD63CB-15G-132	SD63CB-26-132.75
SD63CB-15G-167	SD63CB-26-167
SD63CB-16-167	SD63CB-27-167
SD63CB-17-167	SD63CB-27-167
SD63CB-19-167	SD63CB-27-167
SD63CB-20-167	SD63CB-27-167
SD63CB-21-167	SD63CB-27-167
SD63CB-23-118	SD63CB-23-118
SD63CB-23-118R	SD63CB-23-118
SD63CB-5-132	SD63CB-26-132.75
SD63CB-5-167	SD63CB-26-167
SD63CB-6-118	SD63CB-23-118
SD63CB-7-132	SD63CB-26-132.75
SD63CB-7-167	SD63CB-26-167
SD63CB-8-132	SD63CB-26-132.75
SD63CB-8-167	SD63CB-26-167
SD63CB-8-197.44	SD63CB-26-197
SD63CC-20-167	SD63CC-23-167
SD63CC-29-167	SD63CC-39-167
SD63CC-40-164	SD63CC-44-164
SD63CC-40-181	SD63CC-44-181
SD63CC-41-164	SD63CC-44-164
SD63CC-41-181	SD63CC-44-181
SD63CC-48-166.94	SD63CC-39-167
SD63CC-CP640-164	SD63CC-44-164
SD63CC-CP645-181	SD63CC-44-181
SD63DB-13-120	SD63DB-14-120
SD63DB-14G-120	SD63DB-14-120
SD63DB-4-120	SD63DB-14-120
SD63DB-5-120	SD63DB-14-120
SD63DB-9-120	SD63DB-14-120
SD63DD-1-164	SD53CC-48-164
SD63DD-2-164	SD53CC-48-164
SD63DD-2G-164	SD63CC-44-164
SD64CC-11-118	SD64CC-7-118
SD64CC-11-132	SD64CC-7-132
SD64CC-11-152	SD64CC-7-152
SD64CC-6-132	SD64CC-7-132
SD64CC-6-152	SD64CC-7-152
SD64CC-7G-118	SD64CC-7-118
SD64CC-7G-132	SD64CC-7-132
SD64CC-7G-152	SD64CC-7-152
SD64DC-3-145	SD64DC-5-145
SD73CC-25G-120	SD73CC-25-120
SD73CC-9-120	SD73CC-25-120
SD73DB-6-115	SD73DB-10-115
SD73DB-6G-115	SD73DB-10-115
SD74DC-11-119	SD74DC-7-119
SD74DC-CP135-119	SD74DC-7-119
SD83CB-13-117	SD83CB-16-117
SD83CB-15-117	SD83CB-16-117
SD83CB-5-117	SD83CB-16-117
SD83CB-6-117	SD83CB-16-117
SD83CB-7-117	SD83CB-16-117
SD83CC-5-132	SD83CC-24-132
SD83CC-5-156	SD83CC-24-156
SD83LF-3-177	SD83LF-5-177
SD83LF-4-177	SD83LF-5-177
SD84CC-17-178	SD84CC-20-178
SD84CC-5-178	SD84CC-20-178
SD84MC-14-152	SD84MC-18-152

Commercial / Parker

SD84MC-3-152	SD84MC-18-152
SD84MC-3-176	SD84MC-18-176
SD84MC-4-152	SD84MC-18-152
SD84MC-4-176	SD84MC-18-176
SD84MC-8-152	SD84MC-18-152
SD84MC-8-176	SD84MC-18-176
SD84MC-9-152	SD84MC-18-152
SD84MC-9-176	SD84MC-18-176
SD85CC-17-378	SD85CC-19-378
SD85MC-11-220	SD85MC-16-220
SD85MC-15G-220	SD85MC-15-220
SD85MC-16G-220	SD85MC-16-220
SD85MC-3-221	SD85MC-15-220
SD85MC-4-221	SD85MC-15-220
SD85MC-8-220	SD85MC-15-220
SD85MC-9-220	SD85MC-15-220
SD93CC-13-132	SD93CC-13-132
SD93DC-1-177	SD93DC-5-177.12
SD95CC-1-160	SD95CC-3-160
SD95MC-2-220	SD95MC-6-220
SD96CC-1-199	SD96CC-3-199
SD96CC-3G-199	SD96CC-3-199
SD96MC-5G-480	SD96MC-5-480
SD96MC-6-480	SD96MC-5-480

Crysteel

107439	S74DC-74-161
107450	S73DC-66-129
107455	S73DC-66-150
107548	S73DC-66-150
403013	S74DC-74-161
403108	S73DC-66-129
403109	S73DC-66-150
403110	S74DC-74-161
T73129	S73DC-66-129
T73147	S73DC-66-150
T74167	S74DC-74-161

Custom Hoist

32-29-43	S32DB-3-42.62 CM72
42-1-90	S42MB-3-90
42-21-53	S42DB-8-51 CM72
42-38-60	M42MB-60
42-44-60	S42MB-5-60
42-60-43	M52CB-43-P
42-75-43	S42DB-8-43 CM72
42-75-50	S42DB-8-51 CM72
42-76-43	M42DB-43-P
42-790-56	S52CC-41-54.62
42-793-68	S52CC-41-67.25
43-5-72	S43DB-3-75 CM72
43-5-75	S43DB-3-75 CM72
501-25470-03	S84DC-66-170
53-110-81	S53DC-60-81
53-12-122	S53DC-68-123
53-12-99	S53DC-68-99
53-131-110	S53DC-65-107
53-131-130	S53DC-65-126
53-139-104	S53DC-65-104
53-139-130	S53DC-65-130 CM4
53-139-72	S53DC-66-72
53-139-84	S53DC-66-84
53-147-105	S53DC-65-104 CM4
53-147-130	S53DC-65-130 CM4
53-149-99	S53DC-68-99
53-2-104	S53DC-65-104 CM4
53-2-105	S53DC-65-104 CM4
53-2-126	S53DC-65-126 CM4
53-2-130	S53DC-65-130 CM4
53-2-60S	S53DC-66-72 CM4
53-2-72	S53DC-66-72 CM4
53-2-72S	S53DC-66-72 CM4
53-2-74	S53DC-66-72 CM4
53-2-84	S53DC-66-84 CM4
53-2-88	S53DC-66-84 CM4
53-2-90	S53DC-66-84 CM4
53-3-120	S53MB-3-120
53-403-120	S53MB-3-120

Crossover and Application Data is for Reference Purpose Only. No Other Conditions are Expressed or Implied.

Note: It is the Users Responsibility to Verify if the Replacement Cylinder is Interchangeable.

Note: In some applications, modifications may be required for proper cylinder installation.

Quick Reference Guide

Custom Hoist

53-459-105	S53DC-68-105
53-459-122	S53DC-68-123
53-459-128	S53DC-68-123
53-5-110	S53DC-65-107
53-52-120	S53DC-68-120
53-52-130	S53DC-65-130 CM2
53-531-110	S53DC-65-107
53-531-130	S53DC-65-126
53-539-84	S53DC-66-84
53-59-105	S53DC-68-105
53-59-122	S53DC-68-123
53-59-128	S53DC-68-123
53-59-99	S53DC-68-99
53-703-120	S53MB-3-120
53-72-104	S53DC-65-104 CM4
53-72-105	S53DC-65-104 CM4
53-72-130	S53DC-65-130 CM4
53-73-89	S53MB-5-90
53-759-105	S53DC-68-105
53-759-122	S53DC-68-123
53-759-128	S53DC-68-123
53-80-120	S53DC-68-120
53-810-81	S53DC-60-81
53-831-110	S53DC-65-107
53-831-130	S53DC-65-126
53-839-104	S53DC-65-104
53-839-72	S53DC-66-72
53-839-84	S53DC-66-84
53-892-106	S53DC-65-104
53-892-72	S53DC-66-72
53-892-84	S53DC-66-84
63-10-120	S63DC-102-120
63-10-127	S63DC-102-126
63-105-110	S63DC-101-107 CM17
63-105-126	S63DC-97-123 CM63
63-105-142	S63DC-101-140 CM17
63-105-144	S63DC-101-140 CM17
63-105-97	S63DC-101-92 CM17
63-1-104	S63DC-101-104 CM43
63-1-105	S63DC-101-104 CM43
63-1-120	S63DC-101-120 CM45
63-1-130	S63DC-96-130 CM43
63-1-137	S63DC-96-130 CM43
63-1-138	S63DC-96-130 CM43
63-129-107	S63DC-60-106
63-129-126	S63DC-60-125
63-129-80	S63DC-60-79.12
63-129-92	S63DC-60-92
63-153-130	S63DC-102-126
63-153-140	S63DC-102-138
63-157-80	S63DC-101-77 CM22
63-171-121	S63DC-102-120
63-171-125	S63DC-102-126
63-171-139	S63DC-102-138
63-172-108	S63DC-60-106
63-172-126	S63DC-60-125
63-179-104	S63DC-101-104 CM43
63-179-88	S63DC-101-86 CM43
63-1-80	S63DC-101-77 CM43
63-180-104	S63DC-101-104
63-180-108	S63DC-101-107
63-180-111S	S63DC-97-111
63-180-126	S63DC-97-123
63-180-130	S63DC-96-130
63-180-137	S63DC-96-130
63-180-88	S63DC-101-86 CM2
63-182-104	S63MB-11-108
63-182-126	S63MB-9-120
63-182-140	S63MB-8-140
63-182-150	S63MB-8-150
63-182-160	S63MB-8-160
63-183-107	S63DC-101-107 CM38
63-183-125	S63DC-101-126 CM38
63-1-84	S63DC-101-86 CM43
63-184-111	S63DC-97-111 CM11
63-184-123	S63DC-97-123 CM11
63-184-140	S63DC-101-140 CM11
63-185-98	S63DC-101-104 CM36

Custom Hoist

63-186-121	S63DC-102-120
63-186-125	S63DC-102-126
63-186-139	S63DC-102-138
63-186-160	S63DC-102-162
63-1-88	S63DC-101-86 CM43
63-189-126	S63DC-97-123
63-189-130	S63DC-96-130 CM2
63-189-140	S63DC-101-140 CM2
63-191-130	S63DC-96-130 CM2
63-202-121	S63DC-102-120
63-202-125	S63DC-102-126
63-202-139	S63DC-102-138
63-2-100S	S63DC-101-107 CM2
63-2-102	S63DC-101-104 CM2
63-2-104	S63DC-101-104
63-2-105	S63DC-101-104 CM2
63-2-106	S63DC-101-107 CM2
63-2-108	S63DC-101-107
63-21-108	S63DC-101-107 CM36
63-2-111S	S63DC-97-111
63-21-120	S63DC-101-120 CM36
63-2-120	S63DC-101-120
63-2-126	S63DC-97-123
63-2-130	S63DC-96-130 CM2
63-2-132	S63DC-96-130
63-2-137	S63DC-96-130 CM2
63-2-140	S63DC-101-140
63-2-150	S63DC-101-150
63-2-156	S63DC-101-150
63-22-108	S63DC-101-107 CM36
63-22-120	S63DC-101-120 CM36
63-23-98	S63DC-101-104 CM36
63-27-121	S63DC-102-120
63-27-125	S63DC-102-126
63-27-139	S63DC-102-138
63-27-160	S63DC-102-162
63-2-72S	S63DC-101-77 CM2
63-2-74S	S63DC-101-77 CM2
63-2-84	S63DC-101-86
63-2-84S	S63DC-101-86
63-2-87	S63DC-101-86 CM2
63-2-88	S63DC-101-86 CM2
63-2-90	S63DC-101-86 CM2
63-2-92S	S63DC-101-92
63-2-93	S63DC-101-92
63-2-99S	S63DC-101-104 CM2
63-402-104	S63DC-101-104
63-402-108	S63DC-101-107
63-402-120	S63DC-101-120
63-402-126	S63DC-101-126
63-402-132	S63DC-96-130 CM2
63-402-140	S63DC-101-140
63-402-84	S63DC-101-86
63-4-104	S63MB-11-108
63-4-120	S63MB-9-120
63-4-126	S63MB-9-120
63-4-140	S63MB-8-140
63-4-150	S63MB-8-150
63-4-160	S63MB-8-160
63-44-108	S63DC-101-107 CM2
63-44-120	S63DC-101-120 CM2
63-44-126	S63DC-97-123
63-44-130	S63DC-96-130 CM2
63-44-140	S63DC-101-140 CM2
63-4-96	S63MB-11-108
63-5-107	S63DC-101-107 CM38
63-5-125	S63DC-101-126 CM38
63-53-130	S63DC-96-130 CM2
63-54-120	S63DC-101-120 CM2
63-54-78S	S63DC-101-77 CM2
63-553-130	S63DC-102-126
63-553-140	S63DC-102-138
63-579-104	S63DC-101-104 CM43
63-580-126	S63DC-97-123
63-582-140	S63MB-8-140
63-586-125	S63DC-102-126
63-586-139	S63DC-102-138
63-702-104	S63DC-101-104

Custom Hoist

63-702-108	S63DC-101-107
63-702-120	S63DC-101-120
63-702-126	S63DC-101-126
63-702-132	S63DC-96-130
63-702-140	S63DC-101-140
63-702-84	S63DC-101-86
63-8-104	S63DC-101-104 CM11
63-8-111	S63DC-97-111 CM11
63-8-123	S63DC-97-123 CM11
63-8-130	S63DC-101-126 CM11
63-8-140	S63DC-101-140 CM11
63-83-108	S63DC-60-106
63-83-126	S63DC-60-125
63-8-80	S63DC-101-77 CM11
63-8-82	S63DC-96-82.50 CM11
63-882-140	S63MB-8-140
63-8-86	S63DC-101-86 CM11
63-886-121	S63DC-102-120
63-886-125	S63DC-102-126
63-886-139	S63DC-102-138
63-886-150	S63DC-102-150
64-35-135	S64DB-12-135
64-35-156	S64DB-12-156
64-40-156	S64DC-14-156
64-435-135	S64DB-12-135
64-435-156	S64DB-12-156
64-440-156	S64DC-14-156
64-467-156	S64DC-14-156
64-5-156	S64DC-14-156
64-735-135	S64DB-12-135
64-735-156	S64DB-12-156
64-767-156	S64DC-14-156
64-8-156	S64DC-14-156
73-100-110	S73DC-66-110
73-101-130	S73DC-66-129
73-102-150	S73DC-66-150
73-104-124	S73DC-66-124
73-104-130	S73DC-66-129
73-105-140	S74DC-74-140
73-108-130	S73DC-66-129
73-109-120	S73DC-66-120
73-1-110	S73DC-66-110 CM23
73-1-127	S73DC-66-124 CM23
73-1-142	S73DC-66-140 CM23
73-116-140	S73DC-66-140
73-122-150	S73DC-66-150
73-15-115	S73DC-66-110
73-15-130	S73DC-66-129
73-15-135	S73DC-66-129
73-157-141	S73DC-60-142
73-21-120	S73DC-66-120 CM4
73-2-120	S73DC-66-120
73-2-150	S73DC-66-150
73-22-120	S73DC-66-120 CM4
73-25-110	S73DC-66-110 CM4
73-25-120	S73DC-66-120 CM4
73-25-126	S73DC-66-124 CM4
73-26-120	S73DC-66-120
73-26-140	S73DC-66-140
73-26-150	S73DC-66-150
73-28-120	S73DC-66-120
73-28-130	S73DC-66-129
73-28-132	S73DC-66-129
73-28-140	S73DC-66-140
73-28-150	S73DC-66-150
73-29-108S	S73DC-66-110
73-29-110S	S73DC-66-110
73-29-120	S73DC-66-120
73-29-120S	S73DC-66-124
73-29-124	S73DC-66-124
73-29-124S	S73DC-66-129 CM2
73-29-130	S73DC-66-129
73-29-142	S73DC-66-140
73-3-110	S73DC-66-110
73-3-115	S73DC-66-110
73-3-120	S73DC-66-120
73-3-130	S73DC-66-129
73-3-140	S73DC-66-140

Crossover and Application Data is for Reference Purpose Only. No Other Conditions are Expressed or Implied.
Note: It is the Users Responsibility to Verify if the Replacement Cylinder is Interchangeable.
Note: In some applications, modifications may be required for proper cylinder installation.

Quick Reference Guide

Custom Hoist

73-3-150	S73DC-66-150
73-35-110	S73DC-66-110
73-429-120	S73DC-66-120
73-457-125	S73DC-60-125
73-457-141	S73DC-60-142
73-457-145	S73DC-60-142
73-500-110	S73DC-66-110
73-500-118	S73DC-66-120
73-500-127	S73DC-66-124
73-500-142	S73DC-66-140
73-500-151	S73DC-66-150
73-50-130	S73DC-66-129
73-504-130	S73DC-66-129
73-55-110	S73DC-66-110
73-55-120	S73DC-66-120
73-55-126	S73DC-66-124
73-57-125	S73DC-60-125
73-57-141	S73DC-60-142
73-57-145	S73DC-60-142
73-757-141	S73DC-60-142
73-78-125	S73DC-60-125
73-78-142	S73DC-60-142
73-800-110	S73DC-66-110
73-800-118	S73DC-66-120
73-800-127	S73DC-66-124
73-800-142	S73DC-66-140
73-800-151	S73DC-66-150
73-81-114	S73DC-66-110 CM26
73-81-129	S73DC-66-124 CM26
73-9-110	S73DC-66-110 CM11
73-9-125	S73DC-66-124 CM11
73-9-129	S73DC-66-124 CM11
73-9-130	S73DC-66-129 CM11
73-94-140	S73DC-66-140
74-100-135	S74DC-74-135 CM11
74-100-142	S74DC-74-140 CM11
74-101-161	S74DC-74-161
74-101-167	S74DC-74-167
74-10-123	S74DC-74-120 CM11
74-10-135	S74DC-74-135 CM11
74-10-142	S74DC-74-140 CM11
74-10-156	S74DC-74-156 CM11
74-102-120	S74DC-74-120
74-102-137	S74DC-74-135
74-103-120	S74DC-74-120 CM4
74-103-137	S74DC-74-135 CM2
74-103-167	S74DC-74-161 CM4
74-104-167	S74MB-5-167
74-107-150	S74MB-3-154
74-107-172	S74MB-3-172
74-1-118	S74DC-74-120
74-1-120	S74DC-74-120
74-1-124S	S74DC-74-135
74-1-126	S74DC-74-120
74-1-135	S74DC-74-135
74-1-137	S74DC-74-135
74-1-138	S74DC-74-135
74-1-140	S74DC-74-140
74-1-140S	S74DC-74-140
74-1-144	S74DC-74-140
74-1-146	S74DC-74-140
74-1-156	S74DC-74-156
74-1-160	S74DC-74-156
74-1-161	S74DC-74-161
74-1-163	S74DC-74-161
74-1-167	S74DC-74-161
74-1-174	S84DC-66-170
74-1-176	S84DC-66-170
74-1-180	S74DC-74-180
74-12-120	S74DC-74-120
74-12-137	S74DC-74-140
74-12-144	S74DC-74-140
74-12-156	S74DC-74-156
74-12-161	S74DC-74-161
74-12-167	S74DC-74-161
74-15-135	S74DC-74-135
74-15-140	S74DC-74-140
74-15-156	S74DC-74-156

Custom Hoist

74-15-161	S74DC-74-161
74-16-135	S74DC-74-135 CM4
74-21-140	S74DC-74-140 CM2
74-21-156	S74DC-74-156 CM4
74-22-140	S74DC-74-135 CM4
74-22-156	S74DC-74-156 CM4
74-27-135	S74DC-74-135 CM4
74-27-156	S74DC-74-156 CM4
74-28-120	S74DC-74-120
74-28-137	S74DC-74-135
74-28-161	S74DC-74-161
74-28-174	S84DC-66-170
74-31-135	S74DC-74-135 CM4
74-31-167	S74DC-74-161 CM4
74-3-135	S74DC-74-135 CM9
74-3-156	S74DC-74-156 CM9
74-3-182	S74DC-74-180
74-34-120	S74DC-74-120 CM4
74-34-137	S74DC-74-135 CM2
74-34-144	S74DC-74-140 CM4
74-34-156	S74DC-74-156 CM4
74-34-167	S74DC-74-161 CM4
74-36-167	S74MB-5-167
74-37-135	S74DC-74-135
74-37-140	S74DC-74-140
74-37-160	S74DC-74-156
74-401-120	S74DC-74-120
74-401-135	S74DC-74-135
74-401-140	S74DC-74-140
74-401-156	S74DC-74-156
74-401-161	S74DC-74-161
74-401-167	S74DC-74-167
74-401-180	S74DC-74-180
74-46-150	S74MB-3-154
74-46-154	S74MB-3-154
74-46-170	S74MB-3-172
74-498-120	S74DC-74-120
74-498-140	S74DC-74-140
74-498-167	S74DC-74-167
74-499-135	S74DC-77-135
74-504-167	S74MB-5-167
74-535-154	S74MB-3-154
74-63-165	S74DC-60-165.75
74-65-154	S74MB-3-154
74-65-170	S74MB-3-172
74-701-120	S74DC-74-120
74-701-135	S74DC-74-135
74-701-140	S74DC-74-140
74-701-156	S74DC-74-156
74-701-161	S74DC-74-161
74-701-167	S74DC-74-167
74-701-180	S74DC-74-180
74-71-154	S74MB-3-154
74-7-120	S74DC-74-120 CM38
74-7-135	S74DC-77-135
74-7-144	S74DC-74-140 CM38
74-7-164	S74DC-74-161 CM38
74-7-166	S74DC-74-161 CM38
74-80-166	S74DC-60-165.75
74-804-167	S74MB-5-167
74-98-120	S74DC-74-120
74-98-140	S74DC-74-140
74-98-167	S74DC-74-161
74-99-135	S74DC-77-135
74-99-166	S74DC-74-161 CM38
8 1/4 4-10-150	S84DC-66-148 CM2
8 1/4 4-10-190	S84DC-66-188 CM2
8 1/4 4-11-150	S84DC-66-148 CM2
8 1/4 4-20-150	S84DC-66-148 CM2
8 1/4 4-4-150	S84DC-66-148 CM2
8 1/4 4-4-190	S84DC-66-188 CM2
8 1/4 5-20-190	S85DC-66-190
8 1/4 5-20-220	S85DC-66-220
8 1/4 5-20-235	S85DC-66-235
8 1/4 5-20-250	S85DC-66-250
8 1/4 5-20-265	S85DC-66-265
8 1/4 5-21-265	S85DC-66-265
8 1/4 5-26-265	S85DC-66-265

Custom Hoist

8 1/4 5-26-270	S85DC-66-265
8 1/4 5-26-285	S85DC-66-285
8 1/4 5-404-220	S85DC-66-220
8 1/4 5-404-235	S85DC-66-235
8 1/4 5-404-250	S85DC-66-250
8 1/4 5-4-190	S85DC-66-190
8 1/4 5-4-220	S85DC-66-220
8 1/4 5-4-235	S85DC-66-235
8 1/4 5-4-250	S85DC-66-250 CM2
8 1/4 5-4-265	S85DC-66-265
8 1/4 5-4-270	S85DC-66-265
8 1/4 5-4-285	S85DC-66-285
83-4-135	S83DC-56-134
83-4-140	S83DC-56-139
83-4-170	S84DC-66-180
84-1-156	S84DC-66-156 CM11
84-13-135S	S84DC-66-140
84-13-140	S84DC-66-140
84-13-148	S84DC-66-148
84-13-150	S84DC-66-148
84-13-150S	S84DC-66-156
84-13-156	S84DC-66-156
84-13-156S	S84DC-66-161
84-13-160	S84DC-66-156
84-13-161	S84DC-66-161
84-13-166	S84DC-66-161
84-13-170	S84DC-66-170
84-13-180	S84DC-66-180
84-13-183	S84DC-66-180
84-13-190	S84DC-66-188
84-14-188	S84DC-66-188 CM9
84-17-150	S84DC-66-148 CM49
84-17-170	S84DC-66-170 CM49
84-17-180	S84DC-66-180 CM49
84-20-140	S84DC-66-140
84-20-150	S84DC-66-148
84-20-175	S84DC-66-170
84-21-140	S84DC-66-140
84-21-156	S84DC-66-156
84-2-140	S84DC-66-140
84-2-150	S84DC-66-148
84-2-156	S84DC-66-156
84-2-160	S84DC-66-156
84-2-165	S84DC-66-161
84-2-170	S84DC-66-170
84-2-174	S84DC-66-170
84-2-181	S84DC-66-180
84-2-188	S84DC-66-188
84-2-190	S84DC-66-188
84-22-140	S84DC-66-140
84-22-156	S84DC-66-156
84-23-156	S84DC-66-156
84-23-170	S84DC-66-170
84-23-190	S84DC-66-188
84-24-140	S84DC-66-140
84-4-140	S84DC-66-140
84-4-166	S84DC-66-161
84-4-180	S84DC-66-180
84-466-148	S84DC-66-148
84-466-156	S84DC-66-156
84-466-160	S84DC-66-156
84-466-161	S84DC-66-161
84-466-166	S84DC-66-161
84-466-170	S84DC-66-170
84-466-180	S84DC-66-180
84-466-183	S84DC-66-180
84-51-188	S84DC-66-188 CM9
84-65-165	S84DC-66-161
84-66-148	S84DC-66-148
84-66-156	S84DC-66-156
84-66-160	S84DC-66-156
84-66-161	S84DC-66-161
84-66-166	S84DC-66-161
84-66-170	S84DC-66-170
84-66-180	S84DC-66-180
84-66-183	S84DC-66-180
84-68-150	S84DC-66-148 CM49
84-69-156	S84DC-66-156

Crossover and Application Data is for Reference Purpose Only. No Other Conditions are Expressed or Implied.

Note: It is the Users Responsibility to Verify if the Replacement Cylinder is Interchangeable.

Note: In some applications, modifications may be required for proper cylinder installation.

Quick Reference Guide

Custom Hoist

84-7-180	S84DC-66-180	CM21
84-72-188	S84DC-66-188	CM9
85-11-162	S85DC-66-160	
85-11-170	S85DC-66-170	
85-11-190	S85DC-66-190	
85-11-200	S85DC-66-197	
85-11-220	S85DC-66-220	
85-11-235	S85DC-66-235	
85-11-250	S85DC-66-250	
85-11-265	S85DC-66-265	
85-11-285	S85DC-66-285	
85-14-190	S85MC-48-200	
85-14-200	S85MC-48-200	
85-14-220	S85MC-48-220	
85-14-235	S85MC-48-235	
85-14-240	S85MC-48-235	
85-14-250	S85MC-48-250	
85-14-265	S85MC-48-265	
85-14-280	S85MC-48-280	
85-16-162	S85DC-66-160	
85-16-220	S85DC-66-220	
85-16-235	S85DC-66-235	
85-16-250	S85DC-66-250	
85-20-170	S85DC-66-170	
85-20-190	S85DC-66-190	
85-20-220	S85DC-66-220	
85-20-235	S85DC-66-235	
85-20-250	S85DC-66-250	
85-20-265	S85DC-66-265	
85-20-285	S85DC-66-285	
85-2-160	S85DC-66-160	
85-2-166	S85DC-66-160	
85-2-170	S85DC-66-170	
85-2-190	S85DC-66-190	
85-2-195	S85DC-66-197	
85-2-200	S85DC-66-197	
85-2-200S	S85DC-66-197	
85-2-220	S85DC-66-220	
85-2-225	S85DC-66-220	
85-2-235	S85DC-66-235	
85-2-250	S85DC-66-250	
85-2-260	S85DC-66-265	
85-2-265	S85DC-66-265	
85-2-270	S85DC-66-265	
85-2-285	S85DC-66-285	
85-28-170	S85DC-66-170	
85-28-190	S85DC-66-190	
85-28-220	S85DC-66-220	
85-28-235	S85DC-66-235	
85-28-250	S85DC-66-250	
85-28-265	S85DC-66-265	
85-28-289	S85DC-66-285	
85-3-203	S85DC-66-197	CM46
85-3-235	S85DC-66-235	CM46
85-3-260	S85DC-66-265	CM46
85-3-265	S85DC-66-265	CM46
85-34-162	S85DC-66-160	
85-34-170	S85DC-66-170	
85-34-190	S85DC-66-190	
85-34-200	S85DC-66-197	
85-34-220	S85DC-66-220	
85-34-235	S85DC-66-235	
85-34-250	S85DC-66-250	
85-34-265	S85DC-66-265	
85-35-220	S85DC-66-220	CM54
85-35-235	S85DC-66-235	CM54
85-402-170	S85DC-66-170	
85-402-190	S85DC-66-190	
85-402-197	S85DC-66-197	
85-402-200	S85DC-66-197	
85-402-220	S85DC-66-220	
85-402-235	S85DC-66-235	
85-402-250	S85DC-66-250	
85-4-190	S85DC-66-190	CM49
85-4-220	S85DC-66-220	CM49
85-4-260	S85DC-66-265	CM49
85-4-265	S85DC-66-265	CM49
85-453-265	S85DC-66-265	

Custom Hoist

85-463-200T	S85MC-48-200	
85-463-220T	S85MC-48-220	
85-463-235T	S85MC-48-235	
85-463-250T	S85MC-48-250	
85-463-265T	S85MC-48-265	
85-463-280T	S85MC-48-280	
85-463-285T	S85MC-48-280	
85-466-265	S85DC-66-265	
85-466-285	S85DC-66-285	
85-499-200	S85MC-48-200	
85-499-220	S85MC-48-220	
85-499-235	S85MC-48-235	
85-499-250	S85MC-48-250	
85-499-265	S85MC-48-265	
85-499-280	S85MC-48-280	
85-5-190	S85DC-66-190	
85-5-220	S85DC-66-220	
85-5-265	S85DC-66-265	
85-5-285	S85DC-66-285	
85-53-265	S85DC-66-265	
85-54-190	S85MC-48-200	
85-54-200	S85MC-48-200	
85-54-220	S85MC-48-220	
85-54-240	S85MC-48-235	
85-54-250	S85MC-48-250	
85-6-162	S85DC-66-160	
85-6-190	S85DC-66-190	
85-6-220	S85DC-66-220	
85-6-235	S85DC-66-235	
85-6-250	S85DC-66-285	
85-6-265	S85DC-66-265	
85-63-190T	S85MC-48-200	
85-63-200T	S85MC-48-200	
85-63-220T	S85MC-48-220	
85-63-235T	S85MC-48-235	
85-63-240T	S85MC-48-235	
85-63-250T	S85MC-48-250	
85-63-265T	S85MC-48-265	
85-63-280T	S85MC-48-280	
85-63-285T	S85MC-48-280	
85-66-195	S85DC-66-197	
85-66-265	S85DC-66-265	
85-66-270	S85DC-66-265	
85-66-285	S85DC-66-285	
85-67-203	S85DC-66-197	CM46
85-67-265	S85DC-66-265	CM46
85-68-260	S85DC-66-265	CM49
85-68-265	S85DC-66-265	CM49
85-69-265	S85DC-66-265	
85-70-265	S85DC-66-265	
85-70-285	S85DC-66-285	
85-73-285	S85DC-66-285	
85-75-265	S85DC-66-265	
85-77-265	S85DC-66-265	
85-81-200T	S85MC-48-200	CM1
85-81-220T	S85MC-48-220	CM1
85-81-235T	S85MC-48-235	CM1
85-81-250T	S85MC-48-250	CM1
85-81-265T	S85MC-48-265	
85-9-162	S85DC-66-160	
85-9-166	S85DC-66-160	
9 3/4 5-11-190	S95DC-52-190	CM4
9 3/4 5-11-235	S95DC-52-235	CM4
9 3/4 5-11-250	S95DC-52-250	CM4
9 3/4 5-11-265	S95DC-52-265	CM4
9 3/4 5-11-300	S95DC-52-300	
9 3/4 5-411-190	S95DC-52-190	CM4
9 3/4 5-411-235	S95DC-52-235	CM4
9 3/4 5-411-250	S95DC-52-250	CM4
9 3/4 5-411-265	S95DC-52-265	CM4
9 3/4 5-411-300	S95DC-52-300	
9 3/4 5-4-190	S95DC-52-190	
9 3/4 5-4-235	S95DC-52-235	
9 3/4 5-4-250	S95DC-52-250	
9 3/4 5-4-260	S95DC-52-265	
9 3/4 5-4-265	S95DC-52-265	
9 3/4 5-4-280	S95DC-52-280	
9 3/4 5-4-300	S95DC-52-300	

Custom Hoist

93-10-110	S93CC-CP112-110	
95-11-190	S95DC-52-190	
95-11-190S	S95DC-52-190	
95-11-200	S95DC-52-190	
95-11-235	S95DC-52-235	
95-11-250	S95DC-52-250	
95-11-260	S95DC-52-265	
95-11-260S	S95DC-52-265	
95-11-264S	S95DC-52-265	
95-11-265	S95DC-52-265	
95-11-265S	S95DC-52-265	
95-11-270	S95DC-52-265	
95-11-280	S95DC-52-280	
95-11-285	S95DC-52-280	
95-11-300	S95DC-52-300	
95-11-320	S95DC-52-320	
95-13-265	S95DC-52-265	
95-20-235	S95DC-52-235	
95-20-250	S95DC-52-250	CM42
95-22-190	S95DC-52-190	
95-22-220	S95DC-52-220	
95-22-235	S95DC-52-235	
95-22-250	S95DC-52-250	
95-22-285	S95DC-52-280	
95-2-235	S95DC-52-235	
95-2-250	S95DC-52-250	
95-2-260	S95DC-52-265	
95-2-300	S95DC-52-300	
95-2-320	S95DC-52-320	
95-3-235	S95DC-52-235	CM9
95-3-250	S95DC-52-250	CM9
95-3-260	S95DC-52-265	CM9
95-38-250	S95DC-52-250	
95-38-265	S95DC-52-265	
95-411-235	S95DC-52-235	
95-4-190	S95DC-52-190	
95-4-235	S95DC-52-235	
95-4-236	S95DC-52-235	
95-4-250	S95DC-52-250	
95-4-250S	S95DC-52-250	
95-4-285	S95DC-52-280	
95-461-250	S95DC-52-250	
95-461-265	S95DC-52-265	
95-461-280	S95DC-52-280	
95-461-300	S95DC-52-300	
95-461-320	S95DC-52-320	
95-53-235	S95DC-52-235	
95-53-250	S95DC-52-250	
95-53-260	S95DC-52-265	
95-53-300	S95DC-52-300	
95-53-320	S95DC-52-320	
95-54-260	S95DC-52-265	CM9
95-55-250	S95DC-52-250	
95-55-285	S95DC-52-280	
95-57-270	S95DC-52-265	CM42
95-61-250	S95DC-52-250	
95-61-260	S95DC-52-265	
95-61-260S	S95DC-52-265	
95-61-265	S95DC-52-265	
95-61-270	S95DC-52-265	
95-61-280	S95DC-52-280	
95-61-285	S95DC-52-280	
95-61-300	S95DC-52-300	
95-61-320	S95DC-52-320	
95-6-235	S95DC-52-235	CM42
95-6-250	S95DC-52-250	CM42
95-6-270	S95DC-52-265	CM42
95-63-265	S95DC-52-265	
96-11-285	S96DC-2-285	
96-19-285	S96DC-2-285	
96-20-285	S96DC-2-285	
96-21-285	S96DC-2-285	
DA25-16-90	D25LD-2-90	
DA3 1/2-52-16	D35LD-7-16	
DA35-52-16	D35LD-7-16	
DA4-126-28	D40DB-7-28.5	
DA4-170-25	D40CD-14-25	
DA45-63-49	D45CD-5-49.12	

Crossover and Application Data is for Reference Purpose Only. No Other Conditions are Expressed or Implied.
Note: It is the Users Responsibility to Verify if the Replacement Cylinder is Interchangeable.
Note: In some applications, modifications may be required for proper cylinder installation.

Quick Reference Guide

Custom Hoist

DA5 1/2-24-24	D55CC-10-24.25
DA5 1/2-50-24	D55CC-10-24.25
DA5 1/2-51-63	D55CC-6-63
DA5-144-36	D50CC-27-36
DA5-47-27	D50CB-8-27
DA55-24-24	D55CC-10-24.25
DA55-50-24	D55CC-10-24.25
DA55-51-63	D55CC-6-63
DA6 1/4-8-80	D62LB-5-80
DA6-140-79	D60DD-20-79
DA6-156-34	D60CF-3-32.38
DA6-157-30	D60BC-5-30.31 536
DA6-158-42	D60DC-12-42.62
DA6-205-30	D60BC-5-30.31 495
DA6-236-72	D60DB-23-72
DA6-288-42	D60DC-12-42.62
DA6-365-72	D60DB-23-72
DA6-406-30	D60BC-5-30.31 495
DA65-33-80	D62LB-5-80
DA6-68-79	D60DD-20-79
DA6-73-34	D60CD-5-34
DA6-81-30	D60BC-5-30.31 536
DA6-96-72	D60DB-23-72
DA7 1/4-1-80	D72LB-9-80
DA7 1/4-5-80	D72LB-9-80
DA7-107-80	D70LN-5-80
DA7-107-90	D70LN-5-90
DA7-144-80	D70LN-5-80
DA7-144-90	D70LN-5-90
DA7-192-80	D70LN-5-80
DA7-192-90	D70LN-5-90
DA7-241-80	D70LN-5-80
DA7-241-90	D70LN-5-90
DA7-250-152	DA7-250-152
DA725-1-80	D72LB-9-80
DA7-255-80	D70LN-5-80
DA725-5-80	D72LB-9-80
DA7-269-79	D70DD-7-79
DA7-333-79	D70DD-9-79
DA7-43-79	D70DD-9-79
DA7-78-79	D70DD-9-79
DA7-82-78	D70DD-9-79
DAT42-19-112	SD42CC-19-111
DAT42-24-112	SD42CC-19-111
DAT42-58-112	SD42CC-19-111
DAT52-24-112	SD52CC-24-111
DAT52-61-112	SD52CC-24-111
DAT53-125-182	SD53CC-51-182
DAT53-159-156	SD53CD-3-156.88
DAT53-159-168	SD53CD-3-168
DAT53-159-186	SD53CD-3-185.75
DAT53-162-182	SD53CC-51-182
DAT54-3-150	SD64CC-7-152
DAT54-4-118	SD64CC-7-118
DAT54-4-136	SD64CC-7-132
DAT54-5-135	SD64CC-7-132
DAT54-8-118	SD64CC-7-118
DAT54-8-136	SD64CC-7-132
DAT62-1-114	SD62CB-12-114
DAT62-18-79	SD62DB-6-79
DAT62-19-114	SD62CB-12-114
DAT62-2-114	SD62CB-12-114
DAT62-31-114	SD62CB-12-114
DAT62-3-79	SD62DB-6-79
DAT62-55-114	SD62CB-12-114
DAT62-61-79	SD62DB-6-79
DAT62-69-79	SD62DB-6-79
DAT63-120-118	SD63CB-23-118
DAT63-137-118	SD63CB-23-118
DAT63-14-120	SD63DB-14-120
DAT63-145-118	SD63CB-23-118
DAT63-146-120	SD63DB-14-120
DAT63-152-118	SD63CB-23-118
DAT63-155-118	SD63CB-23-118
DAT63-157-118	SD63CB-23-118
DAT63-167-118	SD63CB-23-118
DAT63-209-118	SD63CB-23-118
DAT63-2-118	SD63CB-23-118

Custom Hoist

DAT63-37-120	SD63DB-14-120
DAT63-38-118	SD63CB-23-118
DAT63-51-118	SD63CB-23-118
DAT63-63-120	SD63DB-14-120
DAT63-67-118	SD63CB-23-118
DAT63-7-118	SD63CB-23-118
DAT63-95-133	SD63CB-26-132.75
DAT63-95-167	SD63CB-26-167
DAT63-NEED-167	SD63CC-39-167
DAT64-31-136	SD64CC-7-132
DAT64-35-150	SD64CC-7-152
DAT64-53-118	SD64CC-7-118
DAT73-20-120	SD73CC-25-120
DAT73-78-120	SD73CC-25-120
DAT84-11-178	SD84CC-20-178
DAT84-14-152	SD84MC-18-152
DAT84-14-176	SD84MC-18-176
DAT84-38-178	SD84CC-20-178
DAT84-40-178	SD84CC-20-178
DAT84-43-178	SD84CC-20-178
DAT84-50-178	SD84CC-20-178
DAT84-51-152	SD84MC-18-152
DAT84-51-176	SD84MC-18-176
DAT84-57-178	SD84CC-20-178
DAT84-61-178	SD84CC-20-178
DAT85-25-378	SD85CC-19-378
DAT85-26-220	SD85MC-16-220
DAT85-27-220	SD85MC-15-220
DAT85-30-378	SD85CC-19-378
DAT85-36-378	SD85CC-19-378
DAT85-46-220	SD85MC-16-220
DAT85-47-220	SD85MC-15-220
DAT85-51-378	SD85CC-19-378
DAT85-55-378	SD85CC-19-378
DAT85-70-378	SD85CC-19-378
DAT85-72-378	SD85CC-19-378
DAT85-84-378	SD85CC-19-378
DAT85-85-378	SD85CC-19-378
DAT85-93-220	SD85MC-16-220
DAT85-94-220	SD85MC-15-220
DAT9 3/4 6-2-200	SD96CC-3-199
DAT9 3/4 6-3-200	SD96CC-3-199
DAT9 3/4 6-6-199	SD96CC-3-199
DAT9 3/4 6-7-199	SD96CC-3-199
DAT9 3/4 6-8-199	SD96CC-3-199
DAT9 3/4 6-199	SD96CC-3-199
DAT95-27-220	SD95MC-6-220
DAT95-32-160	SD95CC-3-160
DAT95-34-220	SD95MC-6-220
DAT96-10-200	SD96CC-3-199
DAT96-15-480	SD96MC-5-480
DAT96-16-480	SD96MC-5-480
DAT96-17-200	SD96CC-3-199
DAT96-28-480	SD96MC-5-480
DAT96-29-480	SD96MC-5-480
DAT96-37-480	SD96MC-5-480
DAT96-38-480	SD96MC-5-480
DAT96-41-480	SD96MC-5-480
DAT96-4-198	SD96CC-3-199
DAT96-4-199	SD96CC-3-199
DAT96-47-480	SD96MC-5-480
DAT96-48-480	SD96MC-5-480
DAT96-48-492	DAT96-48-492
DAT96-50-480	SD96MC-5-480
DAT96-52-480	SD96MC-5-480
SA4-10-39	S41LC-1-39.38

Daybrook

90345593	S53DC-65-107
98045556	S73DC-66-120 CM11
98045557	S73DC-66-124 CM11

Dempster

AB15905	SD96CC-3-199
AB17393	AB17393
AB19600TH	D60CD-5-34
AB19601TH	D50CB-8-27
AB26635TH	D60CD-5-34

Dempster

AB29246	D25LL-16-24
AB29337	D40DD-19-22.50
AB29406	D35CD-10-20
BB6996	D50CB-8-27
BB6997	D60CD-5-34
BB8112	D60CD-5-34
BB8133-1	D60CD-5-34
BB8134-1	D50CB-8-27
BB8235	D50CB-8-27
CB4753	SD96CC-3-199
CB7599	SD96CC-3-199
CB8217	SD96CC-3-199
DB08142	D35CD-10-20
DB1748	SD96CC-3-199
DB4753	SD96CC-3-199
DB5801	SD96CC-3-199
DB8042	D50CB-8-27
DB8043	D60CD-5-34
DB8142	D35CD-10-20
DB-8142	D35CD-10-20
DB8362	D25LL-16-24
DB-8362	D25LL-16-24
DB8439	D40DD-19-22.50
DB9467	D40DD-19-22.50
EAST MFG	
501-25065-13	S85DC-66-265
501-25110-03	S73DC-66-110
501-25110-13	S73DC-66-110
501-25120-13	S73DC-66-120
501-25127-03	S73DC-66-124
501-25150-03	S73DC-66-150
501-25150-08	S73DC-66-150
501-25237-03	S74DC-74-135
501-25237-08	S74DC-74-135
501-25237-13	S74DC-74-135
501-25250-13	S73DC-66-150
501-25255-13	S73DC-66-150
501-25261-03	S74DC-74-161
501-25261-08	S74DC-74-161
501-25261-13	S74DC-74-161
501-25437-13	S84DC-66-140
501-25445-13	S84DC-66-148
501-25448-03	S84DC-66-148
501-25448-13	S84DC-66-148
501-25460-03	S84DC-66-161
501-25460-08	S84DC-66-156
501-25460-13	S84DC-66-161
501-25480-03	S84DC-66-180
501-25480-13	S84DC-66-180
501-25520-03	S85DC-66-220
501-25520-08	S85DC-66-220
501-25520-13	S85DC-66-220
501-25535-03	S85DC-66-235
501-25535-08	S85DC-66-235
501-25535-13	S85DC-66-235
501-25550-03	S85DC-66-250
501-25550-08	S85DC-66-250
501-25550-13	S85DC-66-250
501-25562-13	S85DC-66-160
501-25565-03	S85DC-66-265
501-25565-08	S85DC-66-265
501-25565-13	S85DC-66-265
501-25569-10	S95DC-52-250 CM22
501-25570-13	S85DC-66-170
501-25585-03	S85DC-66-285
501-25585-13	S85DC-66-285
501-25590-03	S85DC-66-190
501-25590-13	S85DC-66-190
501-25600-03	S95DC-52-300
501-25600-08	S95DC-52-300
501-25600-13	S95DC-52-300
501-25650-03	S95DC-52-250
501-25665-03	S95DC-52-265
501-25665-13	S95DC-52-265
501-25680-03	S95DC-52-280
501-25680-13	S95DC-52-280

Crossover and Application Data is for Reference Purpose Only. No Other Conditions are Expressed or Implied.

Note: It is the Users Responsibility to Verify if the Replacement Cylinder is Interchangeable.

Note: In some applications, modifications may be required for proper cylinder installation.

Quick Reference Guide

Edbro

058003223	S53DC-65-104
058003247	S53DC-65-120
058003401	S63DC-101-107
058003440	S63DC-97-111
058003488	S63DC-101-140
058003820	S85DC-66-235
TE11-3-2660	S53DC-65-104
TE11-3-2960	S53DC-65-120
TE14-3-2670	S63DC-101-107
TE14-3-2850	S63DC-97-111
TE14-3-3450	S63DC-101-140
TE18-5-6170	S85DC-66-235

Energy

A277	D60DB-23-72
A3525	D70LN-5-80
A6430	D60DB-23-72

Esp Mfg / Dragon

243-7004	SD63CB-23-118
----------	---------------

Everlite

9055001	S85DC-66-265
9055004	S85DC-66-190
9055008	S85DC-66-250
9055010	S85DC-66-220
9055025	S74DC-74-161
9055039	S84DC-66-161

Fontaine

53110	S53DC-65-107 CM27
5385	S53DB-18-90
63110	S63DC-101-107 CM17
63126	S63DC-97-123 CM63
63142	S63DC-101-140 CM17
6385	S63DC-101-86 CM17
6397	S63DC-101-92 CM17
73110	S73DC-66-110 CM20
73115	S73DC-66-110 CM20
73126	S73DC-66-124 CM20
73142	S73DC-66-140 CM20
84142	S84DC-66-140 CM20
84152	S84DC-66-148 CM20
84164	S84DC-66-156 CM20
84172	S84DC-66-170 CM20
84188	S84DC-66-180 CM20
85172	S85DC-66-160 CM18
85197	S85DC-66-190 CM53
DCH-31-351	S85DC-66-190 CM53
DCH-31-359	S85DC-66-160 CM18
DCH-31-374	S84DC-66-156 CM20
DCH-31-388	S84DC-66-148 CM20
DCH-31-413	S84DC-66-170 CM20
DCH-31-427	S73DC-66-140 CM20
DCH-31-433	S73DC-66-124 CM20
DCH-31-439	S73DC-66-110 CM20
DCH-31-462	S84DC-66-140 CM20
DCH-31-476	S63DC-101-140 CM17
DCH-31-483	S63DC-97-123 CM63
DCH-31-487	S63DC-101-107 CM17
DCH-31-491	S63DC-101-92 CM17
DCH-31-495	S63DC-101-86 CM17
DCH-31-499	S53DC-65-107 CM27
DCH-31-507	S53DB-18-90
DCH-31-519	S84DC-66-180 CM20
DCH-31-536	S73DC-66-110 CM20

Fruehauf

251147	S84DC-66-170
251147-2	S84DC-66-170
ECA-8950	S85MC-48-220
ECA-8951	S85MC-48-235
ECA-9287	S85MC-48-200
ECB-009287	S85MC-48-200
ECB-2353 X	S85DC-66-235
ECB-2353-1	S85DC-66-220
ECB-2353-10	S85DC-66-170
ECB-2353-101	S85DC-66-220

Fruehauf

ECB-2353-12	S84DC-66-156
ECB-2353-13	S73DC-66-120 CM4
ECB-2353-14	S74DC-74-156 CM4
ECB-2353-15	S63DC-101-120 CM36
ECB-2353-17	S84DC-66-140
ECB-2353-18	S74DC-74-140 CM4
ECB-2353-19	S84DC-66-148 CM2
ECB-2353-2	S85DC-66-190
ECB-2353-20	S63DC-101-107 CM36
ECB-2353-21	S63DC-101-104 CM36
ECB-2353-22	S84DC-66-140
ECB-2353-23	S95DC-52-250
ECB-2353-24	S95DC-52-265
ECB-2353-25	S85DC-66-250
ECB-2353-26	S85DC-66-235
ECB-2353-27	S85DC-66-220
ECB-2353-28	S95DC-52-250
ECB-2353-29	S85DC-66-265
ECB-2353-3	S84DC-66-148
ECB-2353-30	S85DC-66-235 CM2
ECB-2353-31	S85DC-66-250 CM2
ECB-2353-32	S85DC-66-265 CM2
ECB-2353-33	S95DC-52-265
ECB-2353-35	S96DC-2-285
ECB-2353-37	S85DC-66-265 CM2
ECB-2353-38	S84DC-66-148
ECB-2353-39	S85DC-66-265
ECB-2353-41	S63DC-101-120 CM36
ECB-2353-42	S85DC-66-190
ECB-2353-43	S85DC-66-190 CM2
ECB-2353-44	S85DC-66-220 CM2
ECB-2353-45	S96DC-2-285
ECB-2353-46	S95DC-52-250 CM42
ECB-2353-47	S95DC-52-220
ECB-2353-48	S95DC-52-235
ECB-2353-5	S85DC-66-250 CM2
ECB-2353-52	S95DC-52-280
ECB-2353-53	S95DC-52-250 CM42
ECB-2353-54	S85DC-66-190
ECB-2353-55	S85DC-66-220
ECB-2353-56	S85DC-66-190
ECB-2353-57	S85DC-66-220
ECB-2353-6	S85DC-66-235 CM2
ECB-2353-7	S85DC-66-220 CM2
ECB-2353-706	S85DC-66-235
ECB-2353-724	S95DC-52-265
ECB-2353-8	S85DC-66-190 CM2
ECB-2353-9	S85DC-66-250
ECBH2353-1	S85DC-66-220
ECBH2353-10	S85DC-66-170
ECBH2353-12	S84DC-66-148
ECBH2353-2	S85DC-66-190
ECBH2353-29	S85DC-66-265
ECBH2353-3	S84DC-66-140
ECBH2353-5	S85DC-66-250 CM2
ECBH2353-54	S85DC-66-190
ECBH2353-55	S85DC-66-220
ECBH2353-58	S85DC-66-197
ECBH2353-6	S85DC-66-235 CM2
ECBH2353-9	S85DC-66-250
ECBH2353-X	S85DC-66-235
ECC-3366-1	S63DC-101-107 CM16
ECC-3366-2	S63DC-101-120 CM16
ECC-3366-3	S63DC-96-130 CM16
ECE-7681-2	S73DC-66-120 CM4
ECE-7681-3	S74DC-74-156 CM4
ECE-7681-4	S63DC-101-120 CM36
ECE-7681-6	S74DC-74-140 CM4
ECE-7681-7	S63DC-101-107 CM36
ECE-7681-8	S74DC-74-140 CM4
MCU-007401-140	S74DC-74-140
MCU-008413-170	S84DC-66-170
MCU-008502-190	S85DC-66-190
MCU-008520-250	S85DC-66-250
MCU-574DC4-16	S74DC-74-161
MHC-030656	S53MB-3-120
MHC-030657	S95DC-52-235 CM42
MHC-030663	S84DC-66-156

Fruehauf

MHC-030665	S95DC-52-190 CM42
MHC-030666	S84DC-66-170
MHC-030667	SD63DB-14-120
MHC-030668	S95DC-52-220 CM42
MHC-030671	S74DC-74-135 CM4
MHC-030673	S63MB-8-140
MHC-030676	S85DC-66-265
MHC-030680	S74DC-77-135
MHC-030682	S74DC-74-120 CM4
MHC-030684	S95DC-52-250 CM42
MHC-030685	S63MB-11-108
MHC-030686	S85DC-66-190
MHC-030692	S73DC-66-140 CM4
TWC-1391-1	S85DC-66-220
TWC-1391-10	S85DC-66-170
TWC-1391-12	S84DC-66-156
TWC-1391-13	S73DC-66-120 CM4
TWC-1391-14	S74DC-74-156 CM4
TWC-1391-15	S63DC-101-120 CM36
TWC-1391-17	S84DC-66-140
TWC-1391-18	S74DC-74-140 CM2
TWC-1391-19	S84DC-66-148 CM2
TWC-1391-2	S85DC-66-190
TWC-1391-20	S63DC-101-107 CM36
TWC-1391-21	S63DC-101-104 CM36
TWC-1391-22	S84DC-66-140
TWC-1391-23	S95DC-52-250
TWC-1391-24	S95DC-52-235
TWC-1391-25	S95DC-52-190
TWC-1391-27	S85DC-66-220
TWC-1391-29	S85DC-66-265
TWC-1391-3	S84DC-66-148
TWC-1391-35	S96DC-2-285
TWC-1391-37	S85DC-66-265
TWC-1391-38	S84DC-66-148
TWC-1391-46	S95DC-52-250 CM42
TWC-1391-47	S95DC-52-220
TWC-1391-48	S95DC-52-235
TWC-1391-5	S85DC-66-250
TWC-1391-6	S85DC-66-235
TWC-1391-7	S85DC-66-220
TWC-1391-8	S85DC-66-190
TWC-1391-9	S85DC-66-250
TWC-1391-X	S85DC-66-235
TWC-1392-2	S85DC-66-190
TWC-1392-3	S84DC-66-148
TWC-1392-9	S85DC-66-250
TWC-1392-X	S85DC-66-235
TWC-1411-1	S84DC-66-156
TWC-1411-2	S73DC-66-120 CM4
TWC-1411-3	S74DC-74-156 CM4
TWC-1411-4	S63DC-101-120 CM36
TWC-1411-5	S84DC-66-140
TWC-1411-6	S74DC-74-135 CM4
TWC-1411-7	S63DC-101-107 CM36

G&H Mfg

020210	D70DD-9-79
50393	D70DD-9-79
6040004A	D60DD-20-79
7X116GH22778	SD73DB-10-115
A4456	D45DD-8-16.75
AM1161	D70DD-9-79
AM-1161	D70DD-9-79
AM1162	D60DD-20-79
AM-1162	D60DD-20-79
FA1001	D60DD-20-79
FA1002	D70DD-9-79
H1014	D70DD-9-79
H1015	D60DD-20-79
H1020	D40DD-16-29.50
H1238	D45DD-8-16.75
H2208	SD73DB-10-115
H2985	D60DD-20-79
H3291	D60DD-20-79
H3292	D70DD-9-79
H3930	H3930
H5166	SD73DB-10-115

Crossover and Application Data is for Reference Purpose Only. No Other Conditions are Expressed or Implied.
Note: It is the Users Responsibility to Verify if the Replacement Cylinder is Interchangeable.
Note: In some applications, modifications may be required for proper cylinder installation.

Quick Reference Guide

G&H Mfg

H5176	D70DD-9-79
H5393	SD73DB-10-115
P1331	D60DD-20-79
PH-020-002	D40CD-16-29.50
PH-020-168	D60DD-20-79
PH-020-201	D70DD-9-79

Galbreath

1039	D60DB-23-72
1043	D60DB-23-72
1054	D70LN-5-80
1111	SD63CB-23-118
1126	D60DB-23-72
2419	SD62CB-12-114
2455	D70LN-5-90
2460	D70LN-5-80
2463	D70LN-5-90
3116	SD62CB-12-114
3139	SD62CB-12-114
3412	D60DB-23-72
3891	D40CD-16-29.50
3902	SD62CB-12-114
9846	D70LN-5-90
9920	D60DB-23-72
9921	D70LN-5-80
A1002	S84DC-66-188
A1011	S84DC-66-170
A1056	SD85CC-19-378
A1206	S85DC-66-265
A1430	S84DC-66-156
A1527	D60DB-23-72
A1529	D70LN-5-80
A1536	S84DC-66-148
A1537	S84DC-66-170
A1538	S85DC-66-190
A1539	S85DC-66-220
A1540	S85DC-66-235
A1541	S85DC-66-250
A1542	S85DC-66-265
A1587 (95300)	S95DC-52-300
A1606	SD63CB-23-118
A1717	D70LN-5-80
A1745	SD63CB-23-118
A1793	D60DB-23-72
A1825 (84148)	S84DC-66-148
A1826 (84170)	S84DC-66-170
A1827 (85190)	S85DC-66-190
A1828 (85220)	S85DC-66-220
A1829 (85235)	S85DC-66-235
A1830 (85250)	S85DC-66-250
A1831 (85265)	S85DC-66-265
A1897	D70LN-5-80
A1898	D70LN-5-90
A1905	S95DC-52-235
A1961	S95DC-52-220
A1968	D70LN-5-80
A1969	D70LN-5-90
A2083	SD62CB-12-114
A2190	D40CD-16-29.50
A2349	S85DC-66-285
A2564	S95DC-52-250
A2870	S85DC-66-285
A3137	D60DB-23-72
A3147	D70LN-5-80
A3149	D70LN-5-90
A3167	SD62CB-12-114
A3173	SD63CB-23-118
A3377	SD62CB-12-114
A3383	SD63CB-23-118
A3701	SD63CB-23-118
A4543	D60DD-20-79
A4545	D70DD-9-79
A5325	D70LN-5-80
A5331	D60DB-23-72
B1043	D60DB-23-72
B2455	D70LN-5-90
B2460	D70LN-5-80

Galfab

PC145	D70LN-5-80
PC150	D70LN-5-90
PC5	SD63CB-23-118

Godwin

5384-C	S53DC-66-84
5384-H	S53DC-66-84
63120-H	S63DC-97-123
63123-C	S63DC-97-123
73124-C	S73DC-66-124
73124-H	S73DC-66-124
74135-C	S74DC-74-135
74135-H	S74DC-74-135
G5390T	S53MB-5-90

Great Bend

13804GB	SD85MC-15-220
---------	---------------

Green Mfg

600-2570	D55CC-10-24.25
600-2602	D50CC-27-36
600-2812	S41LC-1-39.38
600-2831	D60BC-5-30.31 495
600-3193	D30LL-6-36
600-3194	D35LC-1-60
600-3195	D35LC-1-80

Heil

1-1344	SD64CC-7-132
1-1766	S53DC-68-105
1-1972	S53DC-68-99
1-1973	S53DC-68-120
1-1974	S53DC-68-123
1-2039	S52CC-41-54.62
1-2039-1	S52CC-41-54.62
1-2043	S63DC-102-120
1-2044	S63DC-102-126
1-2123	SD64CC-7-152
1-2298	S63DC-102-138
1-2624	S63DC-102-162
1-2634	S63DC-102-162
1-3058	S53DC-68-120
1-3139	S53DC-68-123
1-3140	S53DC-68-99
1-3141	S53DC-68-105
1-3177	S63DC-102-120
1-3178	S63DC-102-126
1-3179	S63DC-102-138
1-3180	S63DC-102-162
1-3391	SD64CC-7-118
1-3484	S53DC-68-105
1-3689	SD96CC-3-199
1-3717	D25LD-2-90
1-3727	D30CA-2-3.62
1-3830	SD64CC-7-132
1-3836	SD64CC-7-118
1-3843	SD64CC-7-152
1-3860	S53DC-68-123
1-3871	SD64CC-7-132
1-3878	S63DC-96-130
1-3887	S53DC-68-99
1-3888	S53DC-68-105
1-3889	S53DC-68-120
1-3890	S53DC-68-123
1-3891	S63DC-102-120
1-3892	S63DC-102-126
1-3893	S63DC-102-138
1-3983	S53DC-68-99
1-3984	S53DC-68-105
1-3985	S53DC-68-120
1-3986	S53DC-68-123
1-3998	S63DC-102-120
1-3999	S63DC-102-126
1-4000	S63DC-102-138
1-4001	S63DC-102-162
1-4050	SD64CC-7-132
1-4053	SD64CC-7-118
1-4054	SD64CC-7-152

Heil

1-4137	S53DC-68-99
1-4138	S53DC-68-105
1-4139	S53DC-68-120
1-4140	S53DC-68-123
1-4141	S63DC-102-120
1-4142	S63DC-102-126
1-4143	S63DC-102-138
1-4144	S63DC-102-162
1-4347	D55CC-10-24.25
1-4807	S52CC-41-54.62
1-4815	S53DC-68-120
1-4824	D50CC-27-36
1-4828	D50CC-27-36
1-4868	D40CD-14-25
1-4884	D50CC-27-36
1-4887	D55CC-10-24.25
1-4891	S52DB-9-67.50
1-4903	D40CD-8-22
1-4915	D50CC-24-34.19
1-5070	SD53CC-51-151.5
1-5088	D30CC-17-28.19
1-5098	D45CC-19-41.50
1-5110	D50CC-27-36
1-5111	D55CC-10-24.25
1-5146	D55CC-6-63
1-5147	SD53CC-51-182
1-5149	SD53CC-51-151.5
1-5150	D45CC-19-41.50
1-5173	S53MB-3-120
1-5174	S63MB-9-120
1-5175	S63MB-8-140
1-6067	SD53CC-51-182
1-6069	D40CD-13-37
1-6070	D30CC-13-21.62
1-6076	SD53CC-51-182
1-6078	SD53CC-51-151.5
1-6093	D30CC-27-27.50
1-6117	S63DC-79-67
1-6121	S52DB-9-67.50
1-6122	S53MB-3-120
1-6126	D40CC-27-19
1-6135	S63MB-9-120
1-6142	D30CC-13-21.62
1-6152	S63MB-8-140
1-6153	D30CA-2-3.62
1-6155	S63DC-102-150
1-6157	S52CC-41-54.62
1-6160	D30CC-20-8.00
1-6161	D30CC-19-16.00
1-6162	D17AE-2-71.88
1-6163	D30CC-11-18.50
1-6164	D50CC-25-43
1-6169	D30CC-18-8.00
1-6184	S63MB-8-160
1-6191	S52CC-41-54.62
1-6194	D17AE-2-71.88
1-6230	D55CC-6-63
1-6247	SD53CC-51-182
1-6248	D30CC-27-27.50
1-6252	SD53CC-51-151.5
1-6298	D30CC-27-27.50
1-6316	SD53CC-51-151.5
1-6318	SD53CC-51-182
1-6330	D30CC-18-8.00
1-6331	D30CC-18-8.00
1-6369	D40CD-14-25
1-6370	D45CC-19-41.50
1-6384	D40CD-8-22
1-6385	D40CC-27-19
1-6386	D25LD-2-90
1-6388	D45CC-19-41.50
1-6399	D17AE-2-71.88
1-6402	D30CC-18-8.00
1-6403	D17AE-2-71.88
1-6404	D30CC-19-16.00
1-6405	D30CC-11-18.50
1-6406	D50CC-25-43
1-6407	D30CC-20-8.00

Crossover and Application Data is for Reference Purpose Only. No Other Conditions are Expressed or Implied.
Note: It is the Users Responsibility to Verify if the Replacement Cylinder is Interchangeable.
Note: In some applications, modifications may be required for proper cylinder installation.

Quick Reference Guide

Heil

1-6416	D30CC-18-8.00
1-6425	S52CC-41-67.25
1-6427	SD64DC-7-133.12
1-6445	S52CC-41-54.62
1-6456	D55CC-9-35.88
1-6457	D55CC-7-24
1-6521	D30CC-17-28.19
1-6522	D30CA-2-3.62
1-6525	D55CC-6-63
1-6554	D30CE-11-18.50
1-6560	D50CC-24-34.19
1-6581	D50CC-25-43
1-6597	SD53CC-51-182
1-6598	SD53CC-51-151.5
1-6610	D50CC-27-36
1-6611	D55CC-10-24.25
1-6666	D32CC-15-16
1-6669	D40CD-14-25
1-6670	D40CD-8-22
1-6671	D40CC-27-19
1-6703	S53DC-68-123
1-6704	S63DC-102-126
1-6705	S63DC-102-138
1-6711	S53DC-68-105
1-6712	S53DC-68-120
1-6714	S63DC-102-120
1-6715	S63DC-102-150
1-6716	S63DC-102-162
1-6720	D30CA-2-3.62
1-6721	D30CC-17-28.19
1-6757	D17AE-2-71.88
1-6767	D32CC-15-16
1-6777	D40CD-14-25
1-6813	D45CC-19-41.50
1-6819	D30CC-27-27.50
1-6445	S52CC-41-54.62

Henderson Mfg

80960	S74DC-74-140
-------	--------------

Hercules Hyd

HMW-3016	D30DD-16-16.00
SHC-M32DB-43	S32DB-3-42.62 CM72
SHC-M32DB-50	S32DB-3-50 CM72
SHC-M42DB-43	S42DB-8-43 CM72
SHC-M42DB-50	S42DB-8-51 CM72
SHC-M43DB-75	S43DB-3-75 CM72
SHC-M53DB-60	S53DB-13-60
SHC-M53MB-90	S53MB-5-90

Hilbilt / Commercial

SA63DB-1-110	S63DC-101-107 CM26
SA63DB-1-120	S63DC-101-120 CM26
SA63DB-1-130	S63DC-96-130 CM26
SA63DB-1-140	S63DC-101-140 CM26

Huge Haul

01-0207	SD63CB-23-118
4-01-0207	SD63CB-23-118

Hyco

010-9901	D25LL-14-42
010-9901-4	D25LL-14-42
010-9902	D25LL-15-84
010-9902-4	D25LL-15-84
014-0208-0	D35CD-11-19
014-9900	D35LD-5-19
014-9900-4	D35LD-5-19
016-6091	D45LD-7-45.38
016-9900	D40CL-13-45.38
016-9900-0	D40CL-13-45.38
018-9900	D45LD-7-45.38
018-9900-4	D45LD-7-45.38
020-9900	D50DD-25-40
020-9900-0	D50DD-25-40
024-0310-0	D60DD-20-79
028-0314-0	D70DD-9-79
095-6024-2	SD53CD-3-156.88

Hyco

095-6024-4	SD53CD-3-156.88
095-6029	SD53CD-3-168
095-6029-2	SD53CD-3-168
095-6029-4	SD53CD-3-168
095-6038	SD53CD-3-185.75
10000-84-140	S84DC-66-140
10000-84-148	S84DC-66-148
10000-84-156	S84DC-66-156
10000-84-175	S84DC-66-170
10000-85-190	S85DC-66-190
10000-85-220	S85DC-66-220
10001-85-235	S85DC-66-235
10001-85-250	S85DC-66-250
10002-73-120	S73DC-66-120 CM4
10002-74-140	S74DC-74-140 CM4
10002-74-156	S74DC-74-156 CM4
10002-74-175	S84DC-66-170
10003-63-108	S63DC-101-107 CM36
10003-63-120	S63DC-101-120 CM36
10003-63-98	S63DC-101-104 CM36
10004-84-156	S84DC-66-156
10004-84-190	S84DC-66-188
10014-825-190	S85DC-66-190
10014-825-220	S85DC-66-220 CM2
10015-825-235	S85DC-66-235
10015-825-250	S85DC-66-250
10016-84-180	S84DC-66-180 CM21
10023-85-200	S85DC-66-197 CM46
10023-85-205	S85DC-66-197 CM46
10023-85-220	S85DC-66-220 CM46
10027-63-102	S63DC-101-104
10027-63-108	S63DC-101-107
10027-63-120	S63DC-101-120
10027-63-132	S63DC-96-130
10027-63-156	S63DC-101-150
10027-63-84	S63DC-101-86
10027-63-90	S63DC-101-86
10027-64-156	S64DC-14-156
10029-85-235	S85DC-66-235
10029-85-250	S85DC-66-250
10038-85-190T	S85MC-48-200
10038-85-220T	S85MC-48-220
10041-74-118	S74DC-74-120
10041-74-138	S74DC-74-135
10042-85-170	S85DC-66-170
10048-63-140T	S63MB-8-140
10050-73-120	S73DC-66-120 CM38
10050-73-135	S73DC-66-129 CM38
10050-74-135	S74DC-77-135
10050-74-140	S74DC-77-135
10050-74-164	S74DC-74-161 CM38
10051-74-154T	S74MB-3-154
10051-74-172T	S74MB-3-172
10052-53-120T	S53MB-3-120
10053-42-90T	S42MB-3-90
10054-85-190T	S85MC-48-200 CM53
10054-85-200T	S85MC-48-200 CM53
10054-85-220T	S85MC-48-220 CM53
10060-63-120T	S63MB-9-120
10060-63-140T	S63MB-8-140
10060-64-140T	S64MB-4-140
10076-63-108	S63DC-101-107 CM16
10076-63-120	S63DC-101-120 CM16
10097-84-140H	S84DC-66-140
10097-84-156H	S84DC-66-156
10098-73-120H	S73DC-66-120 CM4
10098-74-140H	S74DC-74-140 CM4
10098-74-156H	S74DC-74-156 CM4
10099-63-108H	S63DC-101-107 CM36
10099-63-120H	S63DC-101-120 CM36
10127-64-140H	S74DC-74-140 CM4
10156-935-190	S95DC-52-190 CM42
10156-935-220	S95DC-52-220 CM42
10156-935-235	S95DC-52-235 CM42
10156-935-250	S95DC-52-250 CM42
1054A-87654-204	S85DC-66-197 CM9
1109A-87654-235	S85MC-48-235
1139A-543-119	S53MB-3-120

Hyco

1139A-543-120	S53MB-3-120
1139A-543-120T	S53MB-3-120
1139A-654-104	S63MB-11-108
1139A-654-108	S63MB-11-108
1139A-654-110	S63MB-11-108
1139A-654-119	S63MB-9-120
1139A-654-140	S63MB-8-140
1139A-6543-140	S64MB-4-140
1139A-7654-150	S74MB-3-154
1139A-7654-154	S74MB-3-154
1168A-87654-190	S85MC-48-200
1168A-87654-220	S85MC-48-220
1174A-87654-190T	S85MC-48-200 CM53
1174A-87654-200T	S85MC-48-200 CM53
1174A-87654-220T	S85MC-48-220 CM53
1221A-654-119	S63DC-101-120
1221A-7654-119	S74DC-74-120
1221A-7654-137	S74DC-74-135
1221A-8765-137	S84DC-66-140
1221A-87654-166	S85DC-66-170
1221A-87654-220	S85DC-66-190
1221A-87654-220	S85DC-66-220
1296A-975-8765-190	S95DC-52-190 CM42
1296A-975-8765-220	S95DC-52-220 CM42
1296A-975-8765-235	S95DC-52-235 CM42
1296A-975-8765-250	S95DC-52-250 CM42
1315A-87654-235	S85DC-66-235
1317A-7654-175	S84DC-66-170
1317A-8765-150	S84DC-66-148
1317A-8765-175	S84DC-66-170
1317A-87654-190	S85DC-66-190
1317A-87654-220	S85DC-66-220
1325A-825-765-150	S84DC-66-148 CM2
1325A-825-765-182	S84DC-66-180
1325A-825-7654-170	S85DC-66-170 CM2
1325A-825-7654-190	S85DC-66-190
1325A-825-7654-195	S85DC-66-190 CM2
1325A-825-7654-204	S85DC-66-197 CM2
1325A-825-7654-220	S85DC-66-220
1325A-825-7654-235	S85DC-66-235
1325A-825-7654-250	S85DC-66-250
1325A-825-7654-252	S85DC-66-250 CM2
1395A-8765-148	S84DC-66-148 CM21
1395A-8765-160	S84DC-66-156 CM21
1395A-8765-164	S84DC-66-161 CM21
1395A-8765-180	S84DC-66-180 CM21
1395A-8765-182	S84DC-66-180 CM21
1395A-87654-195	S85DC-66-190 CM21
1395A-87654-220	S85DC-66-220 CM21
1427A-654-104	S63DC-101-104 CM9
1503A-7654-119	S74DC-74-120 CM26
1503A-7654-135	S74DC-74-135 CM26
1503A-8765-153	S84DC-66-148 CM19
1542A-87654-250	S85DC-66-250
1548A-654-108	S63DC-101-107 CM16
1548A-654-119	S63DC-101-120 CM16
1584A-87654-170	S85DC-66-170
1617A-87654-220	S85DC-66-220
1672A-654-120	S63DC-101-120
1741A-87654-220	S85DC-66-220
1761A-654-120	SD63DB-14-120
1788A-8765-182	S84DC-66-180
1788A-87654-220	S85DC-66-220
1913A-654-108	S63DC-101-107 CM36
1913A-654-120	S63DC-101-120 CM36
1913A-765-120	S73DC-66-120 CM4
1913A-7654-141	S74DC-74-140 CM4
1913A-7654-156	S74DC-74-156 CM4
1913A-8765-141	S84DC-66-140
1913A-8765-156	S84DC-66-156
1920A-765-120	S73DC-66-120 CM38
1920A-765-135	S73DC-66-129 CM38
1920A-7654-135	S74DC-77-135
1920A-7654-140	S74DC-77-135
1920A-7654-164	S74DC-74-161 CM38
1936A-765-140	S73DC-66-140
1942A-8765-156	S84DC-66-156
1942A-8765-190	S84DC-66-188

Crossover and Application Data is for Reference Purpose Only. No Other Conditions are Expressed or Implied.

Note: It is the Users Responsibility to Verify if the Replacement Cylinder is Interchangeable.

Note: In some applications, modifications may be required for proper cylinder installation.

Quick Reference Guide

Hyco

1942A-87654-220..... S85DC-66-220
 1967A-7654-158..... S74DC-74-156 CM45
 1967A-8765-138..... S84DC-66-140 CM38
 1967A-8765-152..... S84DC-66-156 CM38
 1967A-8765-162..... S84DC-66-161 CM38
 1967A-8765-170..... S84DC-66-170 CM38
 1967A-8765-187..... S84DC-66-188 CM38
 20028-96-198..... SD96CC-3-199
 20032-916-198..... SD96CC-3-199
 20043-63-120..... SD63DB-14-120
 20059-84-178..... SD84CC-20-178
 20089-42-112..... SD4CC-19-111
 20099-64-132..... SD64CC-7-132
 20099-64-152..... SD64CC-7-152
 20124-63-120..... SD63DB-14-120
 20134-62-114..... SD62CB-12-114
 20155-64-134..... SD64CC-7-132
 20158-64-118..... SD64CC-7-118
 20170-85-378..... SD85CC-19-378
 20184-63-120..... SD63DB-14-120
 20223-64-132..... SD64CC-7-132
 20223-64-152..... SD64CC-7-152
 20234-63-118..... SD63CB-23-118
 20235-52-111..... SD52CC-24-111
 20237-62-114..... SD62CB-12-114
 20254-916-480..... SD96MC-5-480
 20258-915-160..... SD95CC-3-160
 20283-74-164..... 20283-74-164
 20318-63-118..... SD63CB-23-118
 20348-62-114..... SD62CB-12-114
 20565-85-378..... SD85CC-19-378
 20577-63-167..... SD63CB-26-167
 20580-63-132..... SD63CB-26-132.75
 20601-63-120..... SD63DB-14-120
 20641-63-120..... SD63DB-14-120
 20683-63-118..... SD63CB-23-118
 207374-62-114..... SD62CB-12-114
 20738-63-118..... SD63CB-23-118
 30000-83-132..... S83DC-56-134
 30000-83-138..... S83DC-56-139
 30000-83-160..... S84DC-66-170
 30000-84-140..... S84DC-66-140
 30000-84-148..... S84DC-66-148
 30000-84-156..... S84DC-66-156
 30000-84-164..... S84DC-66-161
 30000-84-168..... S84DC-66-161
 30000-84-170..... S84DC-66-170
 30000-84-175..... S84DC-66-170
 30000-84-180..... S84DC-66-180
 30000-84-188..... S84DC-66-188
 30000-84-190..... S84DC-66-188
 30000-85-160..... S85DC-66-160
 30000-85-165..... S85DC-66-160
 30000-85-170..... S85DC-66-170
 30000-85-190..... S85DC-66-190
 30000-85-195..... S85DC-66-190
 30000-85-200..... S85DC-66-197
 30000-85-220..... S85DC-66-220
 30001-85-225..... S85DC-66-220
 30001-85-235..... S85DC-66-235
 30001-85-250..... S85DC-66-250
 30001-85-260..... S85DC-66-265
 30001-85-265..... S85DC-66-265
 30001-85-270..... S85DC-66-265
 30004-824-150..... S84DC-66-148 CM2
 30004-825-190..... S85DC-66-190
 30004-825-220..... S85DC-66-220
 30009-84-148..... S84DC-66-148 CM21
 30009-84-160..... S84DC-66-156 CM21
 30009-84-164..... S84DC-66-161 CM21
 30009-84-180..... S84DC-66-180 CM21
 30009-84-182..... S84DC-66-180 CM21
 30009-85-195..... S85DC-66-190 CM21
 30009-85-220..... S85DC-66-220 CM21
 30011-84-188..... S84DC-66-188 CM9
 30016-73-120..... S73DC-66-120 CM4
 30016-73-130..... S73DC-66-129 CM4
 30016-73-132..... S73DC-66-129 CM4

Hyco

30016-73-140..... S73DC-66-140 CM4
 30016-73-141..... S73DC-66-140 CM4
 30016-73-150..... S73DC-66-150 CM4
 30016-73-151..... S73DC-66-150 CM4
 30016-74-120..... S74DC-74-120 CM4
 30016-74-135..... S74DC-74-135 CM4
 30016-74-136..... S74DC-74-135 CM4
 30016-74-140..... S74DC-74-140 CM4
 30016-74-156..... S74DC-74-156 CM4
 30016-74-164..... S74DC-74-161 CM4
 30016-74-166..... S74DC-74-161 CM4
 30016-74-168..... S74DC-74-161 CM4
 30016-74-175..... S84DC-66-170
 30016-74-176..... S84DC-66-170
 30016-74-180..... S74DC-74-180
 30017-63-108..... S63DC-101-107 CM16
 30017-63-120..... S63DC-101-120 CM16
 30017-63-129..... S63DC-96-130 CM16
 30018-74-118..... S74DC-74-120
 30018-74-138..... S74DC-74-140
 30020-84-224T..... S85MC-48-235
 30020-85-190T..... S85MC-48-200
 30020-85-200T..... S85MC-48-200
 30020-85-204T..... S85MC-48-200
 30020-85-220T..... S85MC-48-220
 30020-85-225T..... S85MC-48-220
 30020-85-235T..... S85MC-48-235
 30021-63-104..... S63DC-101-104 CM36
 30021-63-108..... S63DC-101-107 CM36
 30021-63-120..... S63DC-101-120 CM36
 30021-63-126..... S63DC-97-123 CM36
 30021-63-132..... S63DC-96-130 CM36
 30021-63-138..... S63DC-101-140 CM36
 30021-63-75..... S63DC-101-77 CM36
 30021-63-84..... S63DC-101-86 CM36
 30021-63-98..... S63DC-101-92 CM36
 30022-825-235..... S85DC-66-235
 30022-825-242..... S85DC-66-250
 30022-825-250..... S85DC-66-250
 30022-825-255..... S85DC-66-250
 30022-825-265..... S85DC-66-265
 30023-85-170..... S85DC-66-170
 30025-935-190..... S95DC-52-190 CM42
 30025-935-220..... S95DC-52-220 CM42
 30025-935-235..... S95DC-52-235 CM42
 30025-935-240..... S95DC-52-235 CM42
 30025-935-250..... S95DC-52-250 CM42
 30025-935-255..... S95DC-52-250 CM42
 30025-935-265..... S95DC-52-265 CM42
 30025-935-270..... S95DC-52-265 CM42
 30029-825-270..... S85DC-66-265 CM2
 30034-85-220..... S85DC-66-220 CM11
 30038-915-220..... S95DC-52-220 CM4
 30038-915-235..... S95DC-52-235 CM4
 30038-915-250..... S95DC-52-250 CM4
 30038-915-265..... S95DC-52-265 CM4
 30041-84-156..... S84DC-66-156
 30041-84-190..... S84DC-66-188
 30042-85-235..... S85DC-66-235
 30042-85-250..... S85DC-66-250
 30043-85-200..... S85DC-66-197 CM46
 30043-85-205..... S85DC-66-197 CM46
 30043-85-220..... S85DC-66-220 CM46
 30044-85-235..... S85DC-66-235 CM46
 30044-85-250..... S85DC-66-250 CM46
 30044-85-260..... S85DC-66-265 CM46
 30048-73-120..... S73DC-66-120 CM38
 30048-74-135..... S74DC-77-135
 30048-74-140..... S74DC-74-140 CM38
 30048-74-164..... S74DC-74-161 CM38
 30049-42-82T..... S42MB-3-90
 30049-42-83T..... S42MB-3-90
 30049-42-86T..... S42MB-3-90
 30049-42-90T..... S42MB-3-90
 30050-63-108T..... S63MB-11-108
 30050-63-120T..... S63MB-9-120
 30050-63-140T..... S63MB-8-140
 30050-64-140T..... S64MB-4-140

Hyco

30051-85-190..... S85DC-66-190 CM53
 30051-85-215..... S85DC-66-220 CM65
 30057-53-72..... S53DC-66-72
 30057-53-78..... S53DC-66-72
 30057-53-84..... S53DC-66-84
 30057-53-90..... S53DC-66-84
 30058-74-154T..... S74MB-3-154
 30058-74-172T..... S74MB-3-172
 30060-85-235T..... S85MC-48-235
 30060-85-250T..... S85MC-48-250
 30060-85-265T..... S85MC-48-265
 30060-85-280..... S85MC-48-280
 30061-63-98..... S63DC-101-104 CM36
 30062-85-190T..... S85MC-48-200 CM53
 30062-85-200T..... S85MC-48-200 CM53
 30062-85-220T..... S85MC-48-220 CM53
 30063-85-170H..... S85DC-66-170
 30063-85-190H..... S73DC-66-190
 30064-73-120H..... S73DC-66-120 CM4
 30064-74-140H..... S74DC-74-140 CM4
 30064-74-156H..... S74DC-74-156 CM4
 30064-75-170H..... S85DC-66-170
 30065-63-108H..... S63DC-101-107 CM36
 30065-63-120H..... S63DC-101-120 CM36
 30066-64-140H..... S74DC-74-140 CM4
 30070-63-104..... S63DC-101-104 CM43
 30070-63-105..... S63DC-101-107 CM43
 30070-63-108..... S63DC-101-107 CM43
 30070-63-120..... S63DC-101-120 CM45
 30070-63-84..... S63DC-101-86 CM43
 30071-73-126..... S73DC-66-124 CM9
 30071-74-148..... S74DC-74-140 CM9
 30072-53-120T..... S53MB-3-120
 30097-63-105..... S63DC-101-107
 30097-63-108..... S63DC-101-107
 30097-63-111..... S63DC-97-111
 30097-63-120..... S63DC-101-120
 30097-63-132..... S63DC-96-130
 30097-63-156..... S63DC-101-150
 30097-63-81..... S63DC-101-86
 30097-63-93..... S63DC-101-86
 30097-64-156..... S64DC-14-156
 30122-84-164..... S84DC-66-161 CM38
 30122-84-188..... S84DC-66-188 CM38
 30125-935-265..... S95DC-52-265
 30125-935-270..... S95DC-52-265 CM42
 30125-935-280..... S95DC-52-280
 30125-935-285..... S95DC-52-280
 30125-935-300..... S95DC-52-300
 30129-63-108T..... S63MB-11-108
 30129-63-140T..... S63MB-8-140
 30129-63-144T..... S63MB-8-140
 30129-63-150T..... S63MB-8-150
 30129-64-140T..... S64MB-4-140
 30146-63-129..... S63DC-96-130
 30164-825-250..... S85DC-66-250 CM46
 30178-825-260..... S85DC-66-265 CM49
 30181-53-104..... S53DC-65-104
 30181-53-120..... S53DC-65-120
 30195-73-108..... S73DC-66-110
 30195-73-110..... S73DC-66-110
 30195-73-120..... S73DC-66-120
 30195-73-123..... S73DC-66-120
 30195-73-126..... S73DC-66-124
 30195-73-130..... S73DC-66-129
 30195-73-140..... S73DC-66-140
 30195-73-150..... S73DC-66-150
 30195-74-120..... S74DC-74-120
 30195-74-136..... S74DC-74-135
 30195-74-140..... S74DC-74-140
 30195-74-156..... S74DC-74-156
 30195-74-161..... S74DC-74-161
 30195-74-167..... S74DC-74-161
 30205-74-156..... S74DC-74-156 CM4
 30208-85-235..... S85DC-66-235
 30208-85-250..... S85DC-66-250
 30208-85-265..... S85DC-66-265
 30231-53-104..... S53DC-65-104

Crossover and Application Data is for Reference Purpose Only. No Other Conditions are Expressed or Implied.

Note: It is the Users Responsibility to Verify if the Replacement Cylinder is Interchangeable.

Note: In some applications, modifications may be required for proper cylinder installation.

Quick Reference Guide

Hyco

30231-53-108 S53DC-65-107
30231-53-123 S53DC-65-120
30238-63-138 S63DC-102-138
30238-63-162 S63DC-102-162
30251-63-120 S63DC-102-120
30251-63-126 S63DC-102-126
30251-63-138 S63DC-102-138
30251-63-162 S63DC-102-162
30252-53-105 S53DC-68-105
30252-53-120 S53DC-68-120
30252-53-123 S53DC-68-123
30252-53-126 S53DC-68-123
30252-53-135 S53DC-65-130 CM2
30252-53-81 S53DC-66-84
30252-53-87 S53DC-66-84
30252-53-99 S53DC-68-99
30278-915-190 S95DC-52-190 CM42
30278-915-220 S95DC-52-220 CM42
30278-915-235 S95DC-52-235 CM42
30278-915-250 S95DC-52-250 CM42
30278-915-265 S95DC-52-265 CM42
30279-53-72 S53DC-66-72
30279-53-84 S53DC-66-84
30279-53-90 S53DC-66-84
30305-84-137 S84DC-66-140
30305-84-156 S84DC-66-156
30305-84-160 S84DC-66-156
30305-85-160 S85DC-66-160
30305-85-190 S85DC-66-190
30305-85-220 S85DC-66-220
30320-915-280 S95DC-52-280
30320-915-300 S95DC-52-300
30324-85-285 S85DC-66-285
30337-85-190T S85MC-48-200
30337-85-200T S85MC-48-200
30337-85-204T S85MC-48-200
30337-85-220T S85MC-48-200
30337-85-225T S85MC-48-220
30337-85-235T S85MC-48-235
30338-915-190 S95DC-52-190
30338-915-220 S95DC-52-220
30338-915-235 S95DC-52-235
30338-915-250 S95DC-52-250
30338-915-265 S95DC-52-265 CM4
30346-915-190 S95DC-52-190
30346-915-220 S95DC-52-220
30346-915-235 S95DC-52-235
30346-915-250 S95DC-52-250
30346-915-265 S95DC-52-265
30347-63-104 S63DC-101-104
30347-63-108 S63DC-101-107
30347-63-111 S63DC-97-111
30347-63-120 S63DC-101-120
30347-63-126 S63DC-101-126
30347-63-129 S63DC-96-130
30347-63-130 S63DC-96-130
30347-63-132 S63DC-96-130
30347-63-136 S63DC-96-130
30347-63-138 S63DC-101-140
30347-63-140 S63DC-101-140
30347-63-77 S63DC-101-77
30347-63-84 S63DC-101-86
30347-63-90 S63DC-101-86
30347-63-96 S63DC-101-92
30347-64-156 S64DC-14-156
30357-63-75 S63DC-101-77 CM36
30369-823-213 S85DC-66-235 CM2
30384-53-135 S53DC-65-130 CM2
30387-74-135 S74DC-74-135
30387-74-140 S74DC-74-140
30426-73-120 S73DC-66-120
30426-73-140 S73DC-66-140
30426-73-150 S73DC-66-150
30426-74-120 S74DC-74-120
30426-74-136 S74DC-74-135
30426-74-156 S74DC-74-156
30426-74-161 S74DC-74-161
30433-85-285 S85DC-66-285

Hyco

30434-915-285 S95DC-52-280
30441-916-285 S96DC-2-285
30449-63-105 S63DC-101-107
30449-63-123 S63DC-97-123
30470-64-132 S64DB-12-135
30470-64-135 S64DB-12-135
30493-73-125.25 S73DC-60-125
30494-73-14212 S73DC-60-142
30495-63-09169 S63DC-60-92
30496-53-89 S53MB-5-90
30498-53-81 S53DC-60-81
30499-63-10763 S63DC-60-106
30500-63-126 S63DC-60-125
30504-74-164 S74DC-60-165.75
30505-63-79.63 S63DC-60-79.12
30506-84-162 S84DC-66-161
30521-74-136 S74DC-77-135 CM8
30534-73-120 S73DC-66-120
30534-74-135 S74DC-74-135
30534-74-156 S74DC-74-156
30537-73-142 S73DC-60-142
30541-815-265 S85DC-66-265
30541-85-235 S85DC-66-235
30541-85-240 S85DC-66-235
30541-85-265 S85DC-66-265
30543-63-92 S63DC-60-92
30564-42-67.5 S52DB-9-67.50
30584-63-78 S63DC-101-77 CM71
30592-84-168 S84DC-66-161
30595-74-154 S74MB-3-154
30595-74-172 S74MB-3-172
30602-85-186 S85DC-66-190
30602-85-216 S85DC-66-220
30603-825-186 S85DC-66-190
30603-825-216 S85DC-66-220
30614-73-12525 S73DC-60-125
30616-73-142 S73DC-60-142
30620-63-126 S63DC-60-125
30621-84-162 S84DC-66-161
30779-64-157 S64DC-15-157
40026-85-220 SD85MC-16-220
40041-85-220 SD85MC-16-220
40133-42-55 S52CC-41-54.62
4436-LM D35LD-7-16
50044-64-145 SD64DC-5-145
50044-64-146 SD64DC-5-145
50138-53-182 SD53CC-51-182
60025-935-220 S95DC-52-220 CM42
60251-63-120 S63DC-102-120
60251-63-126 S63DC-102-126
60251-63-138 S63DC-102-138
60251-63-162 S63DC-102-162
60803-53-156 SD53CC-36-155
6260-BA D60CD-5-34
6262-BA D50CB-8-27
6390-BA D60CD-12-42.62
6402 D50CB-8-27
6403 D60CD-5-34
70000-814-132 S84DC-66-140
70000-814-140 S84DC-66-140
70000-814-147 S84DC-66-148
70000-814-155 S84DC-66-156
70000-814-170 S84DC-66-170
70000-814-172 S84DC-66-180
70000-814-191 S84DC-66-188
70000-815-160 S85DC-66-160
70000-815-170 S85DC-66-170
70000-815-180 S85DC-66-190
70000-815-191 S85DC-66-197
70000-815-210 S85DC-66-220
70000-815-235 S85DC-66-235
70000-815-250 S85DC-66-250
70000-815-265 S85DC-66-265
70001-815-235 S85DC-66-235
70001-815-265 S85DC-66-265
70009-814-173.50 S84DC-66-180 CM21
70016-73-120 S73DC-66-120 CM4
70016-73-130 S73DC-66-129 CM4

Hyco

70016-73-140 S73DC-66-140 CM4
70016-74-120 S74DC-74-120 CM4
70016-74-135 S74DC-74-135 CM4
70016-74-140 S74DC-74-140 CM4
70016-74-156 S74DC-74-156 CM4
70016-74-167 S74DC-74-161 CM4
70016-74-180 S74DC-74-180
70018-74-118 S74DC-74-120
70018-74-138 S74DC-74-140
70020-815-190T S85MC-48-200
70020-815-210T S85MC-48-220
70021-63-108 S63DC-101-107 CM36
70021-63-120 S63DC-101-120 CM36
70021-63-132 S63DC-96-130 CM36
70021-63-75 S63DC-101-77 CM36
70021-63-84 S63DC-101-86 CM36
70022-814-172 S84DC-66-180
70022-815-210 S85DC-66-220 CM2
70022-815-235 S85DC-66-235 CM2
70022-815-250 S85DC-66-250 CM2
70022-815-265 S85DC-66-265 CM2
70023-815-170 S85DC-66-170
70025-935-200 S95DC-52-190 CM42
70025-935-220 S95DC-52-220 CM42
70025-935-235 S95DC-52-235 CM42
70025-935-250 S95DC-52-250 CM42
70025-935-265 S95DC-52-265 CM42
70025-935-320 S95DC-52-320 CM42
70029-815-270 S85DC-66-265 CM2
70048-74-135 S74DC-77-135
70049-42-82T S42MB-3-90
70049-42-90T S42MB-3-90
70050-63-108T S63MB-11-108
70050-63-111T S63MB-11-108
70050-63-120T S63MB-9-120
70050-63-140T S63MB-8-140
70050-63-150T S63MB-8-150
70050-63-160T S63MB-8-160
70050-63-98T S63MB-11-108
70050-64-140T S64MB-4-140
70057-53-72 S53DC-66-72
70057-53-84 S53DC-66-84
70057-53-90 S53DC-66-84
70058-74-154T S74MB-3-154
70058-74-172T S74MB-3-172
70060-815-220T S85MC-48-220
70060-815-235T S85MC-48-235
70060-815-250T S85MC-48-250
70060-815-265T S85MC-48-265
70060-815-280T S85MC-48-280
70060-815-285T S85MC-48-280
70061-63-98 S63DC-101-104 CM36
70064-74-140H S74DC-74-140 CM4
70064-74-156H S74DC-74-156 CM4
70072-53-120T S53MB-3-120
70125-935-250 S95DC-52-250
70125-935-265 S95DC-52-265
70125-935-280 S95DC-52-280 CM4
70129-63-108T S63MB-11-108
70129-63-150T S63MB-8-150
70175-73-129H S73DC-66-129 CM4
70195-73-108 S73DC-66-110
70195-73-110 S73DC-66-110
70195-73-120 S73DC-66-120
70195-73-124 S73DC-66-124
70195-73-130 S73DC-66-129
70195-73-140 S73DC-66-140
70195-74-135 S74DC-74-135
70195-74-140 S74DC-74-140
70195-74-156 S74DC-74-156
70195-74-161 S74DC-74-161
70195-74-167 S74DC-74-167
70195-74-180 S74DC-74-180
70251-63-120 S63DC-102-120
70251-63-126 S63DC-102-126
70251-63-138 S63DC-102-138
70251-63-162 S63DC-102-162
70252-53-105 S53DC-68-105

Crossover and Application Data is for Reference Purpose Only. No Other Conditions are Expressed or Implied.
Note: It is the Users Responsibility to Verify if the Replacement Cylinder is Interchangeable.
Note: In some applications, modifications may be required for proper cylinder installation.

Quick Reference Guide

Hyco

70252-53-120	S53DC-68-120
70252-53-123	S53DC-68-123
70252-53-126	S53DC-68-123
70252-53-99	S53DC-68-99
70320-915-300	S95DC-52-300
70320-935-220	S95DC-52-220
70320-935-280	S95DC-52-280
70337-815-200T	S85MC-48-200
70337-815-220T	S85MC-48-220
70338-935-220	S95DC-52-220
70338-935-235	S95DC-52-235
70338-935-250	S95DC-52-250 CM4
70346-935-220	S95DC-52-220
70346-935-235	S95DC-52-235
70346-935-250	S95DC-52-250
70346-935-265	S95DC-52-265
70347-63-104	S63DC-101-104
70347-63-108	S63DC-101-107
70347-63-111	S63DC-97-111
70347-63-120	S63DC-101-120
70347-63-123	S63DC-97-123
70347-63-126	S63DC-101-126
70347-63-130	S63DC-96-130
70347-63-132	S63DC-96-130
70347-63-140	S63DC-101-140
70347-63-77	S63DC-101-77
70347-63-84	S63DC-101-86
70347-63-88	S63DC-101-86
70347-63-96	S63DC-101-92
70347-64-156	S64DC-14-156
70387-74-135	S74DC-74-135
70387-74-140	S74DC-74-140
70387-74-156	S74DC-74-156
70426-73-150	S73DC-66-150
70433-815-285	S85DC-66-285
70434-935-285	S95DC-52-285
70449-63-123	S63DC-97-123
70470-64-132	S64DB-12-135
70470-64-135	S64DB-12-135
70470-64-156	S64DB-12-156
70493-73-124.25	S73DC-60-125
70494-73-142.12	S73DC-60-142
70495-73-125	S73DC-60-125
70498-53-81	S53DC-60-81
70500-63-107	S63DC-60-106
70504-74-162	S74DC-60-165.75
70521-74-136	S74DC-77-135 CM8
70534-74-156	S74DC-74-156
70541-815-210	S85DC-66-220
70541-815-240	S85DC-66-235
70541-815-265	S85DC-66-265
70564-42-67.5	S52DB-9-67.50
70595-74-154T	S74MB-3-154
70595-74-172T	S74MB-3-172
70603-815-180	S85DC-66-190 CM2
70603-815-210	S85DC-66-220 CM2
70611-63-120	S63DC-102-120
70611-63-126	S63DC-102-126
70611-63-138	S63DC-102-138
70611-63-162	S63DC-102-162
70614-73-119	S73DC-66-120 CM38
70616-73-136	S73DC-60-142
70620-63-126	S64DC-10-125
70679-53-123	S53DC-68-123
70802-815-180	S85DC-66-190
70803-815-200T	S85MC-48-200
70803-815-220T	S85MC-48-220
70803-815-240T	S85MC-48-235
70805-64-156	S64DB-12-156
70807-63-120	S63DC-102-120
70809-815-235T	S85MC-48-235
70809-815-250T	S85MC-48-250
70817-73-114	S73DC-66-120
70821-63-91.88	S63DC-101-92
70828-53-123	S53DC-65-126
70832-63-80	S63DC-101-77 CM11
70848-53-84	S53DC-66-84
70850-53-107	S53DC-65-107

Hyco

70850-53-126	S53DC-65-126
70852-63-140	S63DC-101-140
70853-64-140T	S64MB-4-140
70854-64-156	S64DB-12-156
70876-73-146.50	S73DC-66-150
70897-74-140	S74DC-74-140 CM4
7200-LM	D35LD-7-16
8159-BA	D40CD-13-37
8174-BA	D30CC-27-27.50
8201-BA	D40CC-27-19
8208-BA	D30CC-13-21.62
8218-BA	D30CA-2-3.62
8221-BA	D30CC-18-8.00
8224-BA	D17AE-2-71.88
8241-BA	D30CC-18-8.00
8259-BA	D50CC-25-43
8260-BA	D17AE-2-71.88
8261-BA	D30CC-11-18.50
8262-BA	D30CC-18-8.00
8263-BA	D30CC-19-16.00
8533-BA	D40DB-7-28.5
8540-BA	D40CB-10-42
8555-BA	D30LD-8-33.38
8560-BA	D45CD-5-49.12
8565-BA	D40CB-10-42
8575-BA	D40DB-7-28.5
8576-BA	D60DC-12-42.62
8596-BA	D60DC-12-42.62
8597-BA	D40DB-7-28.5
8611-BA	D55CC-12-49.12
8644-BA	D45CD-5-49.12
8671-BA	D40DB-7-28.5
8672-BA	D60DC-12-42.62
9021-BA	D30CC-20-8.00
9066A-825-7654-220	S85DC-66-220 CM46
9066A-825-7654-250	S85DC-66-250 CM46
9066A-87654-202	S85DC-66-197 CM46
9066A-87654-220	S85DC-66-220 CM46
9066A-87654-235	S85DC-66-235 CM46
9066A-87654-250	S85DC-66-250 CM46
9185-6543-140	S64MB-4-140
9185-BA	D50CC-25-43
9189-BA	D17AE-2-71.88
9313-987654-198	SD96CC-3-199
9329-987654-199	SD96CC-3-199
9358-65-114	SD62CB-12-114
9406-8765-178	SD84CC-20-178
9467-654-120	SD63DB-14-120
9530-6543-132	SD64CC-7-132
9530-6543-152	SD64CC-7-152
C6700	D60DB-23-72
RCA-55024-06300	D55CC-6-63

Hyco / Lessard

024-0600-1	D60DB-23-72
028-0500-0	D70LN-5-80
098-2010-0	S84DC-66-148
098-2011-0	S84DC-66-180
098-2012-0	S84DC-66-148
098-2013-0	S84DC-66-180
098-3012-0	S85DC-66-190
098-3013-0	S85DC-66-220
098-3014-0	S85DC-66-235
098-3015-0	S85DC-66-250
098-3016-0	S85DC-66-265
098-3028-0	S85DC-66-190
098-3029-0	S85DC-66-220
098-3030-0	S85DC-66-235
098-3031-0	S85DC-66-250
098-3032-0	S85DC-66-265
099-3004-1	S95DC-52-320 CM42
099-3009-0	S95DC-52-250 CM42
099-3010-0	S95DC-52-190 CM42
099-3011-0	S95DC-52-235 CM42
099-3012-0	S95DC-52-265 CM42
099-3024-0	S95DC-52-190 CM42
099-3025-0	S95DC-52-235 CM42
099-3026-0	S95DC-52-250 CM42

Hyco / Lessard

099-3027-0	S95DC-52-265 CM42
099-3030-0	S95DC-52-320 CM42
193-A	S95DC-52-265 CM42
194-A	S95DC-52-235 CM42
195-A	S95DC-52-190 CM42
196-A	S95DC-52-250 CM42
500-A	S85DC-66-190
500-B	S85DC-66-190
501-A	S85DC-66-220
501-B	S85DC-66-220
502-A	S85DC-66-235
502-B	S85DC-66-235
503-A	S85DC-66-250
503-B	S85DC-66-250
504-A	S85DC-66-265
504-B	S85DC-66-265
519-A	S84DC-66-148
519-B	S84DC-66-148
519-H	S84DC-66-148
520-A	S84DC-66-180
520-B	S84DC-66-180
520-H	S84DC-66-180
DA168.37-53-CB7612	SD53CD-3-168
SA120-5-3-TB-53.75-14.37	S53MB-3-120
SA148.5-8-12-4-BC-54	S84DC-66-148
SA148.5-8-4-BC-54	S84DC-66-148
SA149-8-4-BC-54	S84DC-66-148
SA172.5-8-12-4-BC-60	S84DC-66-180
SA172.5-8-4-BC-60	S84DC-66-180
SA173-8-4-BC-60	S84DC-66-180
SA186-8-5-BC-54	S85DC-66-190
SA190-8-5-BC-54	S85DC-66-190
SA196-912-5-BC-58	S95DC-52-190 CM42
SA216-8-5-BC-60	S85DC-66-220
SA220-8-5-BC-60	S85DC-66-220
SA235-8-5-BC-65	S85DC-66-235
SA235-912-5-BC-66	S95DC-52-235 CM42
SA250-8-5-BC-68	S85DC-66-250
SA250-912-5-BC-69	S95DC-52-250 CM42
SA265-8-5-BC-71	S85DC-66-265
SA265-912-5-BC-72	S95DC-52-265 CM42
SA320-912-5-BC-83	S95DC-52-320 CM42

Hyva

71564118	S63DC-101-107
71564138	S63DC-101-120
71564188	S63DC-101-140
71564238	S64DC-14-156
71565178	S74DC-74-135
71565208	S74DC-74-140
71565238	S74DC-74-156
71565268	S74DC-74-167
71565298	S74DC-74-180
71566238	S84DC-66-156
71566268	S84DC-66-170
71566298	S84DC-66-180
71567418	S85DC-66-197
71567458	S85DC-66-220
71567498	S85DC-66-235
71567538	S85DC-66-235
71567558	S85DC-66-250
71567588	S85DC-66-265
71568458	S95DC-52-220
71568498	S95DC-52-235
71568538	S95DC-52-250
71568558	S95DC-52-265
71568728	S95DC-52-320
FEE129302755231AK1304	S63DC-101-107
FEE129-3-02980	S63DC-101-120
FEE12930280231AK1379	S63DC-101-120
FEE129303460231AK539	S63DC-101-140
FEE129-3-3460	S63DC-101-120
FEE129-3-3460	S63DC-101-140
FEE129-4-3980	S64DC-14-156
FEE149-4-3380	S74DC-74-135
FEE149-4-3680	S74DC-74-140
FEE149-4-3980	S74DC-74-156
FEE149-4-4280	S74DC-74-167

Crossover and Application Data is for Reference Purpose Only. No Other Conditions are Expressed or Implied.
Note: It is the Users Responsibility to Verify if the Replacement Cylinder is Interchangeable.
Note: In some applications, modifications may be required for proper cylinder installation.

Quick Reference Guide

Hyva

FEE149-4-4620	S74DC-74-180
FEE169-4-3980	S84DC-66-156
FEE169-4-4280	S84DC-66-170
FEE169-4-4680	S84DC-66-180
FEE191-5-5355	S85DC-66-197
FEE191-5-5780	S85DC-66-220
FEE191-5-6180	S85DC-66-235
FEE191-5-6480	S85DC-66-235
FEE191-5-6830	S85DC-66-250
FEE191-5-7130	S85DC-66-265
FEE214-5-5780	S95DC-52-220
FEE214-5-6180	S95DC-52-235
FEE214-5-6480	S95DC-52-250
FEE214-5-6830	S95DC-52-265
FEE214-5-8130	S95DC-52-320
FEE6-3-108	S63DC-101-107
FEE6-3-117	S63DC-101-120
FEE6-3-136	S63DC-101-140
FEE8-5-235	S85DC-66-235
FEF6-4-157	S64DC-14-156
FEF7-4-133	S74DC-74-135
FEF7-4-145	S74DC-74-140
FEF7-4-157	S74DC-74-156
FEF7-4-169	S74DC-74-167
FEF7-4-182	S74DC-74-180
FEF8-4-157	S84DC-66-156
FEF8-4-169	S84DC-66-170
FEF8-4-182	S84DC-66-180
FEF8-5-211	S85DC-66-197
FEF8-5-228	S85DC-66-220
FEF8-5-243	S85DC-66-235
FEF8-5-255	S85DC-66-235
FEF8-5-269	S85DC-66-250
FEF8-5-281	S85DC-66-265
FEF9-5-228	S95DC-52-220
FEF9-5-243	S95DC-52-235
FEF9-5-255	S95DC-52-250
FEF9-5-269	S95DC-52-265
FEF9-5-320	S95DC-52-320

J Craft

001679	S63DC-97-123
001682	S63DC-97-111
001683	S73DC-66-129
001684	S74DC-74-156
001685	S85DC-66-190

Johnson

D3-38	S63DC-101-77 CM26
D3-48	S63DC-101-107 CM26
D3-50	S63DC-97-111 CM26
D3-52	S63DC-101-120 CM26
D3-55	S63DC-97-123 CM26
D3-60	S63DC-101-140 CM26
D3-63	S63DC-101-150 CM26
E4-45	S74DC-74-120 CM23
E4-48	S74DC-74-135 CM23
F3-58	S84DC-66-140 CM66
F3-60	S83DC-56-139 CM66
F3-67	S84DC-66-170 CM66
F4-51	S84DC-66-148 CM22
F4-55	S84DC-66-161 CM22
F4-57	S84DC-66-170 CM22
F4-62	S84DC-66-188 CM22
F5-55	S85DC-66-197 CM1
F5-59	S85DC-66-220 CM1
FMD3-38	S63DC-101-77 CM26
FMD3-48	S63DC-101-107 CM26
FMD3-50	S63DC-97-111 CM26
FMD3-52	S63DC-101-120 CM26
FMD3-55	S63DC-97-123 CM26
FMD3-60	S63DC-101-140 CM26
FMD3-63	S63DC-101-150 CM26
FME4-45	S74DC-74-120 CM23
FME4-48	S74DC-74-135 CM23
FMF3-58	S84DC-66-140 CM66
FMF3-60	S83DC-56-139 CM66
FMF3-67	S84DC-66-170 CM66

Johnson

FMF4-51	S84DC-66-148 CM22
FMF4-55	S84DC-66-161 CM22
FMF4-57	S84DC-66-170 CM22
FMF4-62	S84DC-66-188 CM22
FMF5-55	S85DC-66-197 CM1
FMF5-59	S85DC-66-220 CM1
FMG5-55	S95DC-52-190 CM22
FMG5-57	S95DC-52-190 CM22
FMG5-60	S95DC-52-220 CM22
FMG5-62	S95DC-52-220 CM22
FMG5-65	S95DC-52-235 CM22
FMG5-67	S95DC-52-250 CM22
FMG5-69	S95DC-52-250 CM22
FMG5-72	S95DC-52-265 CM22
G5-55	S95DC-52-190 CM22
G5-57	S95DC-52-190 CM22
G5-60	S95DC-52-220 CM22
G5-62	S95DC-52-220 CM22
G5-65	S95DC-52-235 CM22
G5-67	S95DC-52-250 CM22
G5-69	S95DC-52-250 CM22
G5-72	S95DC-52-265 CM22

Kalyn / Siebert

2533038	S85DC-66-197
2533039	S85DC-66-220
2533040	S85DC-66-235
2533047	S95DC-52-280
2533067	S85DC-66-285

Kann Mfg

1400101	D30CD-13-28
1400106	D65CC-9-66
1400121	D40MD-1-72
1400121ABA	D40MD-1-72
1400128	D30LD-10-36
1400135	D35CC-28-38
1400175	D45DD-8-16.75

K-Pac / Krause Corp

21-141	D70LN-5-80
Labrie Equipment	
020-9431-20	D50DC-4-40
HYC00510	D50DC-4-40
HYC01550	D32CC-12-15.50
HYC01550	D32CC-12-15.50

Leach

200869	SD7500-1-100
201500	SD8600-1-146
20278	SD7500-1-100
209787	SD64DC-5-145
2R1006A	D60BC-5-30.31 536
2R1008R	D60BC-5-30.31 495
300679	D60BC-5-30.31 495
300900	D60BC-5-30.31 495
300990	D60BC-5-30.31 495
302525	SD63CC-23-167
303407	SD63CC-23-167
303904	D60BC-5-30.31 495
304000	SD63CC-23-167
304168	D60BC-5-30.31
304805	D60BC-5-30.31 536
305688	SD63CC-39-167
305827	D60BC-5-30.31 495
305972	D60CF-3-32.38
306562	D60BC-5-30.31 495
307081	D60BC-5-30.31
307082	D60BC-6-27.81
32046	D60BC-5-30.31 495
400383	D60CF-3-32.38
400753	S41LC-1-39.38
401056	S41LC-1-39.38
402160	S41LC-1-39.38
402324	S41LC-1-39.38
405089	S41LC-1-39.38
405114	S41LC-1-39.38
406368	D60CF-3-32.38

Leach

406369	S41LC-1-39.38
406399	S41LC-1-39.38
406639	S41LC-1-39.38
41354	D60CF-3-32.38
41357	D60CF-3-32.38
601429	S41LC-1-39.38
620509	D60BC-6-27.81
620568	D60BC-5-30.31
700081	D60BC-5-30.31 528
700289	D60BC-6-27.81 528
704045	704045
717488	D60BC-5-30.31 528
718876	SD64DC-5-145
PO1166	D60CF-3-32.38
PO265	S41LC-1-39.38

Lodal

9930251	SD52CC-24-111
9930254	SD42CC-19-111
9930258	SD95CC-3-160
9930272	SD42CC-19-111
9930303	SD42CC-19-111
9930341	SD53CC-36-155
9930361	SD53CC-36-155

Lufkin

ULD-35	S85DC-66-235
13789850 (3789850)	S85DC-66-265

Mabar

T63108	S63DC-101-107
T63120	S63DC-101-120
T63126	S63DC-97-123
T74135	S74DC-74-135
T74140	S74DC-74-140
T74156	S74DC-74-156

Mailhot

5000011	S85DC-66-190
5000012	S85DC-66-220
5000026	S85DC-66-250
5000058	S95DC-52-250
5000060	S95DC-52-265
5000085	S85DC-66-235
5000134	S95DC-52-235
9000012	S85DC-66-235
9000015	S85DC-66-220
9000016	S95DC-52-265
9000023	S85DC-66-250
9000025	S85DC-66-190
9000029	S95DC-52-250
9000030	S85DC-66-197
9000031	S84DC-66-188
9000034	S74DC-74-135
9000035	S73DC-66-110
9000036	S63DC-97-123
9000037	S63DC-97-111
9000038	S64DC-14-156
9000079	S95DC-52-235
C102-6-3	S63DC-101-104
C111-6-3	S63DC-97-111
C111-7-3	S73DC-66-110
C120-6-3	S63DC-101-120
C123-6-3	S63DC-97-123
C135-7-4	S74DC-74-135
C148-8.125-4	S84DC-66-148
C156-6-4	S64DC-14-156
C156-6-4A	S64DC-14-156
C156-6-4B	S64DC-14-156
C160-7-4	S74DC-74-156
C160-8.125-4	S84DC-66-156
C162-7-4	S74DC-74-161
C167-7-4	S74DC-74-161
C183-8.125-4	S84DC-66-180
C183-8-4	S84DC-66-188
C190-8.125-5	S85DC-66-190
C190-8-5	S85DC-66-190
C190-9.375-5	S95DC-52-190

Crossover and Application Data is for Reference Purpose Only. No Other Conditions are Expressed or Implied.
Note: It is the Users Responsibility to Verify if the Replacement Cylinder is Interchangeable.
Note: In some applications, modifications may be required for proper cylinder installation.

Quick Reference Guide

Mailhot

C200-8-5.....	S85DC-66-197
C220-8-125-5.....	S85DC-66-220
C220-8-5.....	S85DC-66-220
C220-9.375-5.....	S95DC-52-220
C235-8-125-5.....	S85DC-66-235
C235-8-5.....	S85DC-66-235
C235-9.25-5.....	S95DC-52-235
C235-9.375-5.....	S95DC-52-235
C250-8.125-5.....	S85DC-66-250
C250-8-5.....	S85DC-66-250
C250-9.25-5.....	S95DC-52-250
C250-9.375-5.....	S95DC-52-250
C265-8.125-5.....	S85DC-66-265
C265-9.25-5.....	S95DC-52-265
C265-9.375-5.....	S95DC-52-265
C280-9.375-5.....	S95DC-52-280
C300-9.375-5.....	S95DC-52-300
CS132-5.5-3DA.....	SD63CB-26-132.75
CS156.88-5.5-3 DA.....	SD53CD-3-156.88
CS164-5.5-3DA.....	SD63CC-44-164
CS166.25-6.5-3 DA.....	SD63CC-39-167
CS1662.5-6.5-3DA.....	SD63CC-39-167
CS167-6-1/2-3 DA.....	SD63CB-26-167
CS167-6-1/2-3DA.....	SD63CB-27-167
CS181-5.5-3DA.....	SD63CC-44-181
CS197-6.5-3DA.....	SD63CB-26-197
P12040TC5419.....	D40CB-10-42
P12055SS5426.....	D55CC-6-63
PC0601113HG0037.....	S63DC-97-111
PC0601233HG0036.....	S63DC-97-123
PC0601564HG0038.....	S64DC-14-156
PC0701113HG0035.....	S73DC-66-110
PC0701354HG0034.....	S74DC-74-135
PC0701624HG0033.....	S74DC-74-161
PC0701784HG0261.....	S74DC-74-180
PC0801834HG0031.....	S84DC-66-188
PC0801905HG0025.....	S85DC-66-190
PC0802005HG0030.....	S85DC-66-197
PC0802205HG0015.....	S85DC-66-220
PC0802355HG0012.....	S85DC-66-235
PC0802505HG0023.....	S85DC-66-250
PC0802705HG0023.....	S85DC-66-265
PC0922355HG0047.....	S95DC-52-235
PC0922505HG0029.....	S95DC-52-250
PC0922655HG0016.....	S95DC-52-265
PCD0551573BC0629.....	SD53CD-3-156.88
P12050555455.....	D50CC-24-34.19
PS0601023HG0033.....	C102-6-3
PS0601113HG0045.....	S63DC-97-111
PS0601203HG0052.....	S63DC-101-120
PS0601564HG0041.....	S64DC-14-156
PS0601564HG0043.....	S64DC-14-156
PS0701354HG0012.....	S74DC-74-135
PS0701604HG0044.....	S74DC-74-156
PS0701674HG0081.....	S74DC-74-161
PS0811484HG0009.....	S84DC-66-148
PS0811604HG0010.....	S84DC-66-156
PS0811834HG0011.....	S84DC-66-180
PS0811905HG0001.....	S85DC-66-190
PS0812205HG0003.....	S85DC-66-220
PS0812355HG0004.....	S85DC-66-235
PS0812655HG0006.....	S85DC-66-265
PS0912505HG0005.....	S85DC-66-250
PS0931905HG0020.....	S95DC-52-190
PS0932205HG0008.....	S95DC-52-220
PS0932355HG0022.....	S95DC-52-235
PS0932505HG0023.....	S95DC-52-250
PS093265HG0024.....	S95DC-52-265
PS0932805HG0024.....	S95DC-52-280
PS0933005HG0026.....	S95DC-52-300
PSD0551323HC0326.....	SD63CB-26-132.75
PSD0551573BC0362.....	SD53CD-3-156.88
PSD0551643SS0317.....	SD63CC-44-164
PSD0551683BC0360.....	SD53CD-3-168
PSD0551743BC0365.....	SD53CD-3-156.88
PSD0551813SS0306.....	SD63CC-44-181
PSD0551863BC0361.....	SD53CD-3-185.75
PSD0651663SC0243.....	SD63CC-39-167

Mailhot

PSD0651973TC0295.....	SD63CB-26-197
PSD0651673SS0294.....	SD63CB-27-167
PSD0651673TC0293.....	SD63CB-26-167
SM1-22-4.42.....	D40CB-10-42
SM1-22-42.75.....	D50CC-25-43
SM1-22-5-43.25.....	D50CC-25-43
SM2-22-4.5-52.75.....	D45DD-10-52.75
SM6-22-5-345.....	D50CC-24-34.19
SM6-22-3-16.....	D30CC-19-16.00
SM6-22-3-18.5.....	D30CE-11-18.50
SM6-22-3-8.....	D30CC-20-8.00
SM6-22-4.5-41.5.....	D45CC-19-41.50
SM6-22-5-5-63.....	D55CC-6-63

Marathon

04-0127.....	D70DD-7-79
04-2000.....	D60DB-23-72
04-2001.....	SD63CB-23-118
04-2003.....	D70LN-5-90

Marion Farnsworth

3243C.....	S32DB-3-42.62 CM72
3250-C.....	S32DB-3-50 CM72
4243C.....	S42DB-8-43 CM72
4250C.....	S42DB-8-51 CM72
4260T.....	M42MB-60
4375C.....	S43DB-3-75 CM72
5360C.....	S53DB-13-60
5390C.....	S53DB-18-90
5390T.....	S53MB-5-90
A218630-119.....	S74DC-74-120 CM26
A218630-135.....	S74DC-74-135 CM26
M32DB-43.....	S32DB-3-42.62 CM72
M32DB-50.....	S32DB-3-50 CM72
M32DB-50-0X.....	S32DB-3-50
M42DB-43.....	S42DB-8-43 CM72
M42DB-43-P.....	M42DB-43-P
M42DB-50.....	S42DB-8-51 CM72
M42DB-50S.....	S42DB-8-51
M42MB-60.....	M42MB-60
M42MB-60-S.....	S42MB-5-60
M43DB-75.....	S43DB-3-75 CM72
M43DB-75S.....	S43DB-3-75
M52CB-43-P.....	M52CB-43-P
M53DB-60.....	S53DB-13-60
M53DB-90.....	S53DB-18-90
M53MB-90.....	S53MB-5-90
M53MB-90-PG.....	S53MB-5-90

Maxon

401826.....	D35LD-7-16
D2604.....	D35LD-7-16

McClain

1001160.....	S85DC-66-250
1001163.....	S85DC-66-235
1002190.....	D62LB-5-80
1002191.....	D72LB-9-80
HCL85X235.....	S85DC-66-235
HCL85X250.....	S85DC-66-250
HCL96X480.....	SD96MC-5-480

McClain Ez Pack

20-04001.....	3782000014
20-41381.....	D40CB-10-42
20-43726.....	D40DB-7-28.5
20-43727.....	D40DB-7-28.5
20-44095.....	D60DC-12-42.62
20-44969.....	D40DB-7-28.5
20-44973.....	D60DC-12-42.62
20-46076.....	D40DB-7-28.5
20-46077.....	D60DC-12-42.62
20-46119.....	D45CD-5-49.12
20-46159.....	D40CB-10-42
20-46163.....	D45CD-5-49.12
20-46171.....	D45CD-5-49.12
20-46372.....	D40DB-7-28.5
20-47048.....	D30LD-8-33.38

McClain Ez Pack

20-47088.....	D40CB-10-42
20-47091.....	D40DB-7-28.5
20-47092.....	D60DC-12-42.62
20-48279.....	D60DC-12-42.62
20-48280.....	D40DB-7-28.5
20-48519.....	D55CC-12-49.12
20-49273.....	D45CD-5-49.12
20-49277.....	D45CD-5-49.12
20-49897.....	D40DB-7-28.5
20-49898.....	D60DC-12-42.62
20-52344.....	D45CD-5-49.12
20-52347.....	D30LD-8-33.38
20-52355.....	D55CC-12-49.12
21-01530.....	D60DC-12-42.62
21-01531.....	D40DB-7-28.5
21-01987.....	SD63CB-26-197
21-02220.....	D40DB-7-25.62
21-02610.....	D40DB-7-25.62
21-02832.....	D40CB-10-42
21-03153.....	D40LD-10-24.75
21-03854.....	SD52CB-6-132.75
21-04536.....	SD63CB-26-132.75
21-04537.....	SD63CB-26-167
21-04538.....	SD63CB-26-197
21-05358.....	D45CD-4-49.12
21-06096.....	SD63CB-27-167
21-09228.....	D40LD-11-24.75
21-12851.....	D55CC-12-49.12
21-14658.....	D40DB-7-28.5
21-14659.....	D60DC-12-42.62
21-14661.....	D40DB-7-25.62
21-15639.....	D55CC-12-49.12
21-15641.....	D45CD-4-49.12
21-15642.....	D40LD-11-24.75
21-15644.....	D30LD-8-33.38
21-15770.....	SD63CB-26-167
21-15771.....	SD63CB-27-167
21-15772.....	SD63CB-26-197
21-15773.....	SD63CB-26-132.75
21-16048.....	SD52CB-6-132.75
4028BDA.....	D40DB-7-28.5
4028CDA.....	D40DB-7-28.5
4028DA.....	D40DB-7-28.5
4549DA.....	D45CD-5-49.12
6042ADA.....	D60DC-12-42.62
6042DA.....	D60DC-12-42.62
70-1251.....	SD85CC-19-378
70-1510.....	SD85CC-19-378
70-1549.....	SD85CC-19-378
70-1592.....	SD63CB-26-167
70-1601.....	SD63CB-26-132.75
70-1619.....	SD63CB-26-167
70-1627.....	SD63CB-26-132.75
70-1632.....	SD85CC-19-378
70-1730.....	SD63CB-26-167
70-1731.....	SD63CB-26-132.75
85378DA.....	SD85CC-19-378
C3033EDA.....	D30LD-8-33.38
C4025NDA.....	D40DB-7-25.62
C4025RDA.....	D40LD-11-24.75
C4028MDA.....	D40DB-7-28.5
C4549NDA.....	D45CD-4-49.12
C52133CDA.....	SD52CB-6-132.75
C5549CDA.....	D55CC-12-49.12
C6042MDA.....	D60DC-12-42.62
C63133ADA.....	SD63CB-26-132.75
C63133EDA.....	SD63CB-26-132.75
C63167BDA.....	SD63CB-26-167
C63167HDA.....	SD63CB-26-167
C63167JDA.....	SD63CB-27-167
C63198DDA.....	SD63CB-26-197
C85378DDA.....	SD85CC-19-378
D3033ADA.....	D30LD-8-33.38
D4028DDA.....	D40DB-7-28.5
D4028EDA.....	D40DB-7-28.5
D4028FDA.....	D40DB-7-28.5
D4028GDA.....	D40DB-7-28.5
D4028KDA.....	D40DB-7-28.5

Crossover and Application Data is for Reference Purpose Only. No Other Conditions are Expressed or Implied.

Note: It is the Users Responsibility to Verify if the Replacement Cylinder is Interchangeable.

Note: In some applications, modifications may be required for proper cylinder installation.

Quick Reference Guide

McClain Ez Pack

D4042BDA.....	D40CB-10-42
D4042CDA.....	D40CB-10-42
D4549ADA.....	D45CD-5-49.12
D4549BDA.....	D45CD-5-49.12
D4549DDA.....	D45CD-5-49.12
D4549EDA.....	D45CD-5-49.12
D5549DA.....	D55CC-12-49.12
D6042BDA.....	D60DC-12-42.62
D6042CDA.....	D60DC-12-42.62
D6042DDA.....	D60DC-12-42.62
D6042HDA.....	D60DC-12-42.62
D63133DA.....	SD63CB-26-132.75
D63167DA.....	SD63CB-26-167
D85378BDA.....	SD85CC-19-378
D85378CDA.....	SD85CC-19-378
J4549FDA.....	D45CD-5-49.12
K3033DDA.....	D30LD-8-33.38
K4025GDA.....	D40DB-7-25.62
K4025JDA.....	D40LD-10-24.75
K4025KDA.....	D40LD-11-24.75
K4028LDA.....	D40DB-7-28.5
K4042DDA.....	D40CB-10-42
K4549LDA.....	D45CD-5-49.12
K4549MDA.....	D45CD-4-49.12
K52133DA.....	SD52CB-6-132.75
K5549ADA.....	D55CC-12-49.12
K5549BDA.....	D55CC-12-49.12
K6042LDA.....	D60DC-12-42.62
K63133CDA.....	SD63CB-26-132.75
K63133DDA.....	SD63CB-26-132.75
K63167DDA.....	SD63CB-26-167
K63167FDA.....	SD63CB-26-167
K63167GDA.....	SD63CB-27-167
K63198ADA.....	SD63CB-26-197
K63198BDA.....	SD63CB-26-197

McNeilus (MTM)

0126256.....	D45DD-10-52.75
0604124.....	SD53CC-48-164
0604126.....	D60DC-13-65.75
0604134.....	D50DD-29-25.62
0604135.....	D55DD-14-38.62
0604136.....	S31CB-2-42
0604137.....	SD74DC-7-119
0604145.....	D45DD-9-23
0604146.....	D50DD-30-32.50
0604976.....	D50DD-32-37.25
0606971.....	SD63DC-CP493-46
0614333.....	D35CC-27-26
0614366.....	D45CC-20-46
0614371.....	D20DD-8-95
0619882.....	D32LL-11-38
0619891.....	D45CC-20-46
0626003.....	SD85MC-15-220
0635876.....	D50DD-28-39.50
0651550.....	D62LB-5-80
0660778.....	D20DD-8-95
0661950.....	SD63CC-44-164
0661951.....	SD63CC-44-181
1000067.....	D32LL-11-38
1000068.....	D35CC-27-26
1000069.....	D45CC-20-46
1000077.....	D20DD-8-95
1000081.....	SD53CC-48-164
1000094.....	D50DD-28-39.50
1000160.....	D20DD-8-95
1100031.....	D45DD-10-52.75
1100038.....	D60DC-13-65.75
1105524.....	D30CE-11-18.50
1106845.....	D40LD-10-24.75
1106846.....	D45CD-5-49.12
1107471.....	SD63CB-26-167
1107676.....	D50CC-25-43
1107976.....	D50CC-25-43
1107995.....	D17AE-2-71.88
1107996.....	D30CC-20-8.00
1108091.....	D30CC-17-28.19
1108092.....	D55CC-6-63

McNeilus (MTM)

1108093.....	D40CD-13-37
1108095.....	S52DB-9-67.50
1108097.....	D30CC-19-16.00
1108107.....	D45CC-19-41.50
1108108.....	D30CC-18-8.00
1108110.....	D30CC-19-16.00
1108286.....	D55DD-14-38.62
1108287.....	D50DD-29-25.62
1108291.....	D50DD-30-32.50
1108292.....	D45DD-9-23
1108293.....	S31CB-2-42
1108973.....	D60BC-5-30.31
1109039.....	SD53CC-51-182
1109094.....	D17AE-2-71.88
1109095.....	D30CE-11-18.50
1109096.....	D30CC-20-8.00
1109097.....	D30CC-18-8.00
1109279.....	D30CC-20-8.00
1109305.....	SD63CC-39-167
1109314.....	SD64DC-5-145
1109368.....	D50DB-32-37.25
1109612.....	S41LC-1-39.38
1109698.....	D30CA-2-3.62
1109699.....	D60DB-23-72
1109700.....	D70LN-5-80
1130000.....	SD63CC-44-164
1130000R.....	SD63CC-44-164
1130001.....	SD63CC-44-181
1130001R.....	SD63CC-44-181
1130015.....	D30CC-19-16.00
1130637.....	D55CC-9-35.88
1130638.....	D40CD-14-25
1130640.....	D30CC-13-21.62
1130642.....	D50CC-25-43
1130728.....	D17AE-2-71.88
1130729.....	D30CC-19-16.00
1131210.....	D40CD-8-22
1131389.....	D40DB-7-28.5
1131703.....	D30CC-20-8.00
1131704.....	D30CE-11-18.50
1131705.....	D50CC-25-43
1132626.....	D20DD-6-6.25
1132629.....	D20DD-6-6.25
1132746.....	D60CL-2-40
1132757.....	SD63CB-23-118
1132770.....	D30CE-11-18.50
1132771.....	D30CC-20-8.00
1132774.....	D17AE-2-71.88
1132775.....	D30CC-19-16.00
1136597.....	S52CC-41-54.62
1136607.....	SD53CC-51-151.5
1136614.....	D30CC-27-27.50
1137327.....	D40CC-27-19
1137328.....	S52CC-41-54.62
1137329.....	D55CC-7-24
1138697.....	SD63CB-26-197
1139663.....	D40LD-11-24.75
1139665.....	D60DC-12-42.62
1139666.....	D40DB-7-28.5
1140624.....	SD63CC-44-164
1140624R.....	SD63CC-44-164
1140625.....	SD63CC-44-181
1140625R.....	SD63CC-44-181
1141048.....	D30CC-20-8.00
1141057.....	D50CC-25-43
1142328.....	S52CC-41-54.62
1142458.....	SD63CC-44-181
1144059.....	SD63CC-44-164
1144702.....	D20DD-8-95
1144703.....	D32LL-11-38
1144704.....	D35CC-27-26
1144708.....	D45CC-20-46
1145282.....	D45DD-10-52.75
1145283.....	D20DD-6-6.25
1145616.....	D35DD-7-17.88
1145648.....	D20DD-6-6.25
1146285.....	D62LB-5-80
1147920.....	SD74DC-7-119

McNeilus (MTM)

1148071.....	SD52DC-CP626-38
1148237.....	D72LB-9-80
1149090.....	D25LL-16-24
1149192.....	D40CD-14-25
1149523.....	D40CB-10-42
1149552.....	D35CD-10-20
1149557.....	D40DD-19-22.50
1149600.....	D50DC-4-40
1149968.....	D45CC-19-41.50
1151008.....	D60DC-13-65.75
1151133.....	D20DD-6-6.25
1151216.....	D25LL-15-84
1151217.....	D25LL-14-42
1151218.....	D40CL-13-45.38
1151219.....	D45LD-7-45.38
1151220.....	D35LD-5-19
1151221.....	D60DD-20-79
1151222.....	D70DD-9-79
1151224.....	D40MD-1-72
1151227.....	D30LD-10-36
1151228.....	D65CC-9-66
1151229.....	D35CC-28-38
1151231.....	D30CD-13-28
1156041.....	SD63CB-27-167
1156070.....	1-6720
1156344.....	S52CC-41-67.25
1164534.....	SD53CD-3-156.88
1164535.....	SD53CD-3-168
1164536.....	SD53CD-3-185.75
1178457.....	D32CC-12-15.50
1179422.....	1179422
1180843.....	D25LD-2-90
1180847.....	D30CC-20-8.00
1180858.....	D45CC-19-41.50
1180859.....	D40CD-8-22
1180860.....	D50CC-24-34.19
1180862.....	D30CC-17-28.19
1180868.....	D30CC-17-28.19
1180871.....	D35LD-7-16.19
1180873.....	D35CD-11-19
1180875.....	1-6720
1181025.....	SD53CC-48-164
1226778.....	D55CC-12-49.12
1227259.....	D30LD-8-33.38
1229097.....	SD64DC-7-133.12
1229475.....	SD53CC-51-151.5
1229476.....	D62LB-5-80
1237803.....	SD63CB-26-132.75
1237805.....	D40CB-10-42
1237806.....	D55CC-6-63
1237809.....	SD63CB-26-167
1237810.....	SD63CB-27-167
1237811.....	SD63CB-26-197
1237812.....	SD63CC-44-181
1254376.....	SD63CC-44-164
1254377.....	D50CC-24-34.19
1257605.....	D40CD-16-29.50
1259507.....	SD53CD-3-156.88
1263111.....	SD53CD-3-168
1263244.....	SD53CD-3-156.88
1263245.....	SD53CD-3-168
1263246.....	SD53CD-3-185.75
1273348.....	D45DD-10-52.75
200.126256.....	D45DD-10-52.75
200.126256R.....	D45DD-10-52.75
200.16418R.....	C3667
2114661.....	D40DB-7-25.62
643705.....	D35DD-7-17.88
643706.....	D20DD-6-6.25
9070.614333.....	D35CC-27-26
9070.614333R.....	D35CC-27-26
9070.651550.....	D62LB-5-80
9070.654695.....	D62LB-5-80
9070.654697.....	D72LB-9-80
9072.604134.....	D50DD-29-25.62
9072.604135.....	D55DD-14-38.62
9072.604137.....	SD74DC-7-119
9170.614371.....	D20DD-8-95

**Crossover and Application Data is for Reference Purpose Only. No Other Conditions are Expressed or Implied.
Note: It is the Users Responsibility to Verify if the Replacement Cylinder is Interchangeable.
Note: In some applications, modifications may be required for proper cylinder installation.**

Quick Reference Guide

McNeilus (MTM)

9170.660778.....	D20DD-8-95
9172.604147.....	D20DD-8-95
9180.651550.....	D62LB-5-80
9180.654697.....	D72LB-9-80
9270.604124.....	SD53CC-48-164
9270.604124R.....	SD53CC-48-164
9270.604126.....	D60DC-13-65.75
9270.604137.....	SD74DC-7-119
9270.606971.....	SD63DC-CP493-46
9270.635876.....	D50DD-28-39.50
9270.673087.....	SD52DC-CP626-38
9272.604124.....	SD53CC-48-164
9272.604126.....	D60DC-13-65.75
9272.604127.....	D32LL-11-38
9370.604124.....	SD53CC-48-164
9370.604127.....	D32LL-11-38
9370.604136.....	S31CB-2-42
9370.619882.....	D32LL-11-38
9430.661950.....	SD63CC-44-164
9430.661951.....	SD63CC-44-181
9470.604124.....	SD53CC-48-164
9470.604134.....	D50DD-29-25.62
9470.604135.....	D55DD-14-38.62
9470.604145.....	D45DD-9-23
9470.604146.....	D50DD-30-32.50
9470.615860.....	D50DD-28-39.50
9470.630861.....	D50DD-28-39.50
9570.614333.....	D35CC-27-26
9570.614366.....	D45CC-20-46
9570.614380.....	D45CC-20-46
9570.619891.....	D45CC-20-46
9570.643705.....	D35DD-7-17.88
9570.643706.....	D20DD-6-6.25
9572.601047.....	D3837
9830.620509.....	D60BC-6-27.81
9830.620698.....	D60BC-5-30.31 536
9870.620568.....	D60BC-5-30.31
9870.620569.....	D60CD-5-34
9870.620645.....	D50CB-8-27
9870.620695.....	D60BC-5-30.31 495
9870.622401.....	D50CC-27-36
9870.622402.....	D55CC-10-24.25
9870.623499.....	D60CF-3-32.38
9870.623999.....	S41LC-1-39.38
9872.623428.....	SD86OO-1-146
9872.626002.....	SD84MC-18-176
9872.626003.....	SD85MC-15-220
9872.626004.....	SD85MC-16-220
9880.623829.....	SD64CC-7-132
9970.601047.....	D3837
9970.604976.....	D50DD-32-37.25

Pak-Mor

2001103.....	SD84MC-18-152
2001105.....	SD84MC-18-176
2001106.....	SD85MC-15-220
2001111.....	SD85MC-16-220
2001116.....	SD95MC-6-220
2001120.....	SD95MC-6-220
4148037.....	D60CL-2-40

Palmer Machine

8-4-148.....	S84DC-66-148
8-4-152 P.....	S84DC-66-148 CM20
8-4-156.....	S84DC-66-156
8-4-180.....	S84DC-66-180
8-4-188.....	S84DC-66-180 CM20
8-5-172.....	S85DC-66-160 CM18
8-5-190 P.....	S85DC-66-190
8-5-220.....	S85DC-66-220

Parts Place

10DB08042C.....	D50CB-8-27
10DB08042F.....	D50CB-8-27
10DB08043F.....	D60CD-5-34
2021-04536C.....	SD63CB-26-132.75
2021-04537C.....	SD63CB-26-167
40307081H.....	D60B-5-30.31

Parts Place

40309787H.....	SD64DC-5-145
652001106C.....	SD85MC-15-220
82HH001H.....	D62LB-5-80
82HH002H.....	D72LB-9-80
87H1020.....	D40CD-16-29.50

Peabody Galion

21-04001.....	3782000014
30-00199.....	S63MC-21-108
30-00201.....	S63MC-21-128
3024CDA.....	3782000014
31-00080.....	S63MC-21-80
31-00215.....	S53MB-5-90
5381.....	S53DC-60-81
5389.....	S53MB-5-90
5389B.....	S53MB-5-90
5389E.....	S53MB-5-90
63108.....	S63DC-60-106
63128.....	S63DC-60-125
6380A.....	S63DC-60-79.12
6380G.....	S63DC-60-79.12
6392.....	S63DC-60-92
6392A.....	S63DC-60-92
70-1022.....	S63DC-60-92
70-1023.....	S84DC-66-188
70-1031.....	S53MB-5-90
70-1040.....	S85DC-66-220
70-1049.....	S85DC-66-220
70-1052.....	S85DC-66-220
70-1061.....	S74DC-74-120 CM38
70-1113.....	S53DC-60-81
70-1115.....	S63DC-60-106
70-1116.....	S63DC-60-6.25
70-1118.....	S73DC-60-125
70-1119.....	S74DC-60-165.75
70-1124.....	S85DC-66-197
70-1125.....	S95DC-52-190
70-1126.....	S95DC-52-220
70-1127.....	S95DC-52-250
70-1262.....	S53MB-5-90
70-1271.....	S73DC-60-142
70-1272.....	S63DC-60-92
70-1328.....	S63DC-60-79.12
70-1431.....	S53MB-5-90
70-1481.....	S53MB-5-90
70-1482.....	S53DC-60-81
70-1483.....	S63DC-60-92
70-1484.....	S63DC-60-106
70-1485.....	S63DC-60-125
70-1486.....	S73DC-60-125
70-1490.....	S63DC-60-79.12
70-1493.....	S73DC-60-142
70-1494.....	S74DC-60-165.75
70-1534.....	S73DC-60-125
70-1554.....	S73DC-60-142
70-1561.....	S63DC-60-92
70-1593.....	S73DC-60-142
70-1603.....	S63DC-60-106
70-1604.....	S63DC-60-125
70-1606.....	S73DC-60-125
70-1608.....	S74DC-60-165.75
70-1611.....	S73DC-60-125
70-1645.....	S73DC-60-125
70-1648.....	S63DC-60-125
70-1649.....	S63DC-60-92
70-1650.....	S63DC-60-106
70-1651.....	S74DC-60-165.75
70-1654.....	S53MB-5-90
70-1658.....	S63DC-60-79.12
70-1669.....	S73DC-60-142
70-1671.....	S53DC-60-81
70-1699.....	S53MB-5-90
70-1735.....	S53DC-60-81
70-1736.....	S63DC-60-79.12
70-1737.....	S63DC-60-106
70-1738.....	S63DC-60-125
70-1739.....	S63DC-60-92
70-1741.....	S73DC-60-125

Peabody Galion

70-1742.....	S73DC-60-142
70-1743.....	S74DC-60-165.75
73126-G.....	S73DC-60-125
73142A.....	S73DC-60-142
74120.....	S74DC-74-120 CM38
74167.....	S74DC-60-165.75
84188-G.....	S84DC-66-188
85204.....	S85DC-66-197
85220.....	S85DC-66-220
95199.....	S95DC-52-190
95230.....	S95DC-52-220
95260.....	S95DC-52-250
C5381L.....	S53DC-60-81
C5389J.....	S53MB-5-90
C63108M.....	S63DC-60-106
C63126M.....	S63DC-60-125
C6380P.....	S63DC-60-79.12
C6392H.....	S63DC-60-92
C73126D.....	S73DC-60-125
C73126J.....	S73DC-60-125
C73142D.....	S73DC-60-142
C73142F.....	S73DC-60-142
C74167F.....	S74DC-60-165.75
D5381F.....	S53DC-60-81
D5389F.....	S53MB-5-90
D63108H.....	S63DC-60-106
D63108K.....	S63DC-60-106
D63128G.....	S63DC-60-125
D63128K.....	S63DC-60-125
D6380M.....	S63DC-60-79.12
D6392E.....	S63DC-60-92
D6392F.....	S63DC-60-92
D73126D.....	S73DC-60-125
D73126E.....	S73DC-60-125
D73126F.....	S73DC-60-125
D73126G.....	S73DC-60-125
D73142B.....	S73DC-60-142
D73142C.....	S73DC-60-142
D74167D.....	S74DC-60-165.75
D74167E.....	S74DC-60-165.75
FD73-142A.....	S73DC-60-142
K5381P.....	S53DC-60-81
K5389K.....	S53MB-5-90
K5389L.....	S53MB-5-90
K63108N.....	S63DC-60-106
K63108R.....	S63MC-21-108
K63128R.....	S63DC-60-125
K63128U.....	S63MC-21-128
K6380T.....	S63DC-60-79.12
K6380W.....	S63MC-21-80
K6392K.....	S63DC-60-92
K73126M.....	S73DC-60-125
K73142G.....	S73DC-60-142
K74167G.....	S74DC-60-165.75

Perfection

375.....	M42DB-43-P
475.....	M52CB-43-P
53105V.....	S53DC-65-104
53120V.....	S53DC-65-120
5372V.....	S53DC-66-72 CM69
5388V.....	S53DC-66-84
63105V.....	S63DC-101-107
63120A.....	S63DC-101-120
63A132V.....	S63DC-96-130
73A132.....	S73DC-66-129
85A195V.....	S85DC-66-190
85A235V.....	S85DC-66-235
A154781.....	S84DC-66-170
A154875.....	S84DC-66-170
A154877.....	S84DC-66-140
A154879.....	S85DC-66-170
A1553380000.....	M42DB-43-P
A1553420000.....	M52CB-43-P
A22275.....	S53DC-65-120
A24176.....	M42DB-43-P
A24976.....	M52CB-43-P
A27123.....	S63DC-101-107
A27134.....	S63DC-101-120

Crossover and Application Data is for Reference Purpose Only. No Other Conditions are Expressed or Implied.

Note: It is the Users Responsibility to Verify if the Replacement Cylinder is Interchangeable.

Note: In some applications, modifications may be required for proper cylinder installation.

Quick Reference Guide

Perfection

A29651	S53DC-65-104
A29652, 53120V	S53DC-65-120
A29732	S53DC-66-84
A29741, 6388V	S63DC-101-86
A58627, 6386V	S63DC-101-86
A59327	S74DC-74-135
A68577	S53DC-66-72 CM69
A68827	S84DC-66-170
A68829	S85DC-66-170
A68832	S95DC-52-220
A68835	S95DC-52-250
A68841	S84DC-66-140
A68859	S63DC-96-130
A69064	S73DC-66-120
A69066	S74DC-74-120
A69067	S74DC-74-135
A69069	S85DC-66-170
A69070	S85DC-66-190
A69071	S85DC-66-220
A69072	S85DC-66-235
A69073	S85DC-66-250
A76479	S73DC-66-129
A80314	S84DC-66-170
A92097	S95DC-52-190
A94464	S85DC-66-235
A98278	S84DC-66-170
A99108	S85DC-66-190

Prince

AG284	D70LN-5-80
AH314	SD63CC-23-167
AW330	B1043
AW331	D70LN-5-80
AW332	D70LN-5-90
AW333	B2461
J1335	D60DB-23-72
S373	SD62CB-12-114
S588	D70LN-5-80
S589	D70LN-5-90

R/S Body

100655	S84DC-66-188 CM22
100665	S84DC-66-170 CM22
100720	S84DC-66-188 CM22
100742	S85MC-48-235
100756	S74DC-74-180
100859	S63DC-101-107 CM26
101055	S95DC-52-250 CM22
700100	S53DC-66-72
700102	S53DC-66-84
700103	S53DC-65-104
700104	S63DC-101-86
700106	S63DC-101-104
700108	S63DC-101-107
700109	S63DC-101-120
700110	S63DC-101-126
700112	S63DC-101-140
700114	S73DC-66-110
700116	S73DC-66-120
700118	S73DC-66-124
700120	S73DC-66-140
700122	S73DC-66-150
700124	S74DC-74-135
700126	S74DC-74-140
700128	S74DC-74-156
700130	S74DC-74-167
700132	S74DC-74-180
700134	S84DC-66-156
700135	S84DC-66-180
700136	S85DC-66-235
700138	S85DC-66-250
700140	S95DC-52-250
700142	S95DC-52-300
700146	S84DC-66-170
700148	S85DC-66-190
700150 RS	S85DC-66-220
700152	S85DC-66-265
700156	S95DC-52-235

R/S Body

700158	S95DC-52-320
700164	S95DC-52-280

Rapid Rail / Heil

L10-00	D17AE-2-71.88
L7-00	D30CC-20-8.00
L8-00	D30CC-19-16.00
P23-00	D50CC-25-43
T11-00	D30CE-11-18.50

Rosenboom Machine

100EM0149	D20DD-6-6.25
100EM0162	D20DD-6-6.25
100EP0026	D20DD-8-95
100GS0028	D32LL-11-38
100HS0058	D35CC-27-26
100HS0074	D35DD-7-17.88
100HV0010	S31CB-2-42
100KT0009	D45CC-20-46
100KV0018-5	D45DD-10-52.75
100KW0012	D45DD-9-23
100LW0017	D50CC-24-34.19
100LX0005	D50DD-29-25.62
100LX0006	D50DD-30-32.50
100LX0007-1	D50DD-32-37.25
100MX0006-1	D55CC-6-63
100MY0003-1	D55DD-14-38.62
102LB0002-5	SD52DC-CP626-38
102NC0004-5	SD63CC-44-164
102NC0005-5	SD63CC-44-181
102NC0013-5	1179422
102NC004-5	SD63CC-44-164
102NC005-5	SD63CC-44-181
102PD0003-5	SD74DC-7-119
120NC0014-5(-16)	SD53CC-48-164

Rudco

P28-022	D62LB-5-80
P28-052	D72LB-9-80

Skytop Brewster

082060-02-51	SD83CC-24-131
082060-02-54	SD83CC-24-132

Somerset Welding

CY-2018 B60-18	D84DB-7-25
----------------	------------

Steco

90015-1	S85MC-48-265
ST-90004	S85DC-66-250
ST-90005	S85DC-66-235
ST-90015	S85DC-66-265
ST-90017	S85DC-66-220
ST-90032	DAT96-48-492

Tesco Williamsons

327-01-100	S42MB-3-90
327-01-103	S53MB-3-120
327-01-104	S63MB-9-120
327-01-106	S63MB-8-140
327-01-107	S74MB-3-154
327-01-108	S74MB-3-172
327-01-127	S74MB-5-167
4290VI	S42MB-3-90
53120VI	S53MB-3-120
63120VI	S63MB-9-120
63140VI	S63MB-8-140
74154VI	S74MB-3-154
74172VI	S74MB-3-172
WFMS-4290T	S42MB-3-90
WFMS-53120T	S53MB-3-120
WHP-53120VI	S53MB-3-120
WHP-63140VI	S63MB-8-140
WHP-74154VI	S74MB-3-154
WHP-74172VI	S74MB-3-172

Texas Hydraulics

HS3520024SA	D35CD-10-20
HS5027048SF	D50CB-8-27
HS6034040SH	D60CD-5-34
S400722432PPAZ	D40DD-19-22.50
TH6079064PA3	D60DD-20-79
TH6079064PA-03	D60DD-20-79
TH7079064PA-5	D70DD-9-79

Ti Brook

701700320	S85DC-66-285
-----------	--------------

Trailmobile

428-3-150	S85DC-66-190 CM53
428-3-151	S85DC-66-220 CM65
428-3-156	S95DC-52-235 CM42
428-3-157	S95DC-52-250 CM42
P1027	SD84CC-20-178

Universal Handling

M612-7000	D45DD-9-23
M612-8000	D50DD-30-32.50

Vector / Guzzler

1200334	S63DC-101-107
1201552	SD63DB-14-120
1202100	SD84MC-18-176

Wabash National

WC1392-2	S85DC-66-190
WC1392-3	S84DC-66-148
WALINGA	
64-16622-6	S85DC-66-220

Ward

5044-165	S74DC-74-161
5054-170	S85DC-66-170
5054-190	S85DC-66-190
5054-220	S85DC-66-220
5054-235	S85DC-66-235

Warren Inc

FHC-50166	S84DC-66-170
FHC-50167	S85DC-66-190
FHC-50168	S85DC-66-220
FHC-50169	S85DC-66-220
FHC-50171	S85DC-66-250
FHC-50172	S85DC-66-265
FHC-50191	S84DC-66-180

Western Trailer

8009-017	S85DC-66-220
----------	--------------

Witke

014-0208	D35CD-11-19
095-6024	SD53CD-3-156.88
100-10-1801	D30DD-16-16.00
100-14-1610	D30DD-16-16.00
E0302160	D35CD-11-19
FL7-A066	D35CD-11-19
FL7-A110	D45LD-7-45.38
FL7-A116	SD53CD-3-156.88
FL7-A117	SD53CD-3-168
FL7-A117W	SD53CD-3-168
FL7-A118	SD53CD-3-185.75
FL7-A118W	SD53CD-3-185.75
FL7-A125	SD53CD-3-156.88
FL7-A125W	SD53CD-3-156.88
FLHC-25	D25LL-14-42
FLHC-26B	D40CL-13-45.38
FLHC-26C	D45LD-7-45.38
FLHC-27	S35LD-5-19
FLHC-28C	D45LD-7-45.38
FLHC-30	SD53CD-3-156.88
FLHC-31	SD53CD-3-168
FLHC-32	SD53CD-3-185.75
FLHC-34	D25LL-15-84
FLHC-42	D30DD-16-16.00

Crossover and Application Data is for Reference Purpose Only. No Other Conditions are Expressed or Implied.

Note: It is the Users Responsibility to Verify if the Replacement Cylinder is Interchangeable.

Note: In some applications, modifications may be required for proper cylinder installation.

Quick Reference Guide

Wittke

MLHC-02	D50DD-25-40
FLHC-07	SD53CD-3-156.88
FLHC-08	SD53CD-3-168
FLHC-18	SD53CD-3-156.88
FLHC-19	SD53CD-3-168
FLHC-20	SD53CD-3-185.75
FLHC-27A	D35LD-5-19

**Crossover and Application Data is for Reference Purpose Only. No Other Conditions are Expressed or Implied.
Note: It is the Users Responsibility to Verify if the Replacement Cylinder is Interchangeable.
Note: In some applications, modifications may be required for proper cylinder installation.**



Dynaco Hydraulic Co., Ltd.
Huilong Industrial Zone 39
Ningbo, Zhejiang, China
Tel: 86-25-85360418
Email: info@dynacohydraulic.com
Web: www.dynacohydraulic.com